

RubbaHatch™ 70x32 Watertight Composite Hatch Seal

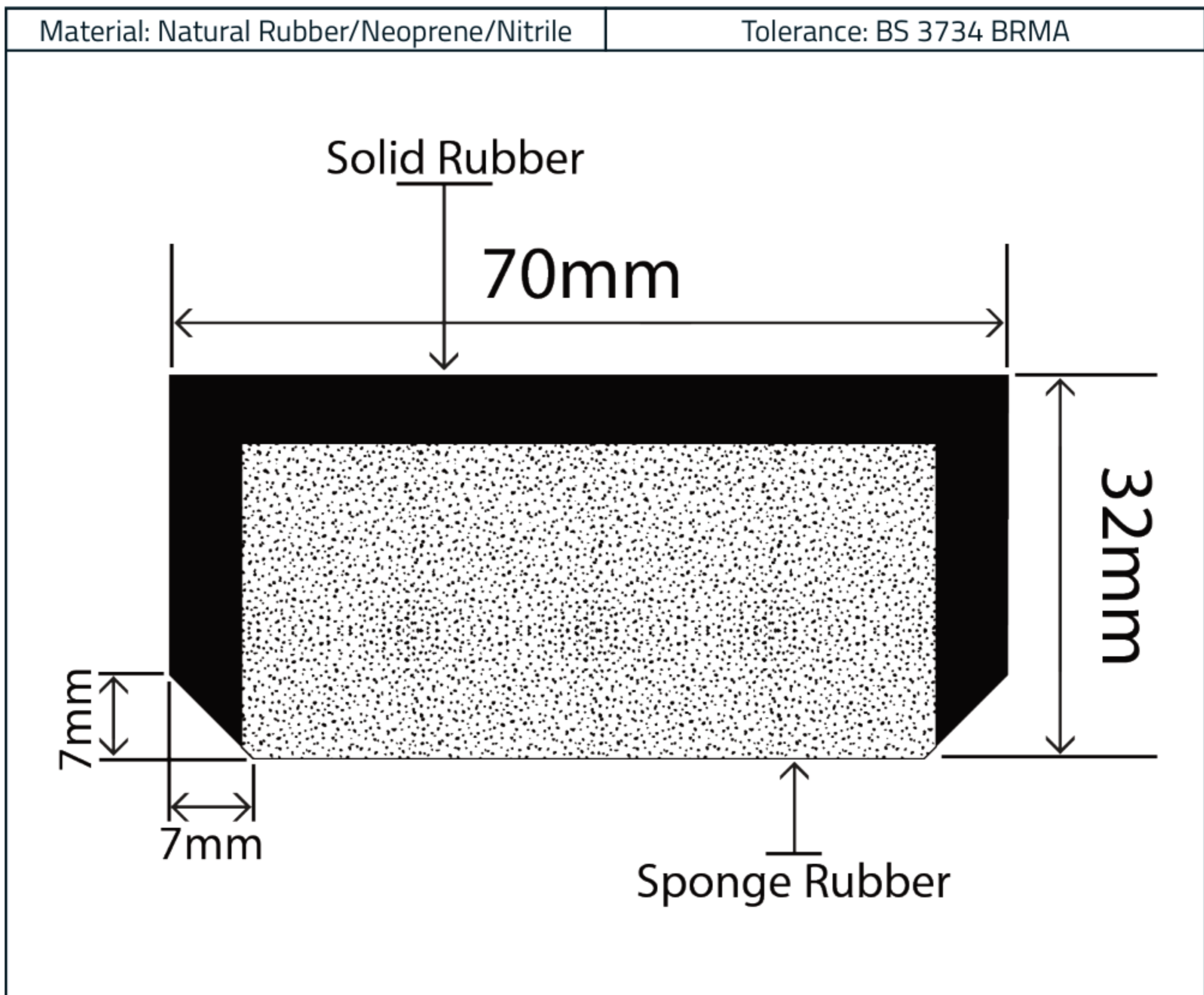

Measurements:

Height	Width	Weight	Standard Coil Length
32mm	70mm	2100g per metre	10m

The information contained on this product information sheet is to be used as guidance. The advice is given in good faith and does not constitute any guarantee or recommendation for suitability. The Rubber Company cannot be held liable for any damage caused by incorrect installation. We hereby reserve the right to change the technical information herewith without notification or prior agreement.

Technical Data

Natural Rubber - Outer Rubber Skin Material Specification

Properties	Values
Polymer	Natural Rubber / SBR
Hardness (Shore A)	60° / 70°
Operating Temperature Range	-20°C to +120°C
Density (Specific Gravity)	1.30 kg/cm ³
Tensile Strength	4.0 MPa
Compression Set (20% Deflection at 70°C)	15% (Maximum)
Elongation at Break	200%
Tolerances	BS3734 BRMA

Neoprene Rubber - Outer Rubber Skin Material Specification

Properties	Values
Polymer	Neoprene
Hardness (Shore A)	70° +/- 5°
Operating Temperature Range	-30° to +120°C
Density (Specific Gravity)	1.30 kg/cm ³
Tensile Strength	5.0 MPa
Surface Finish	Cloth Finish
Test Code	ISO 4100
Compound Resistance	Oil/Heat/Chemical/Weathering/Ozone
Tolerances	BS3734 BRMA



The information contained on this product information sheet is to be used as guidance. The advice is given in good faith and does not constitute any guarantee or recommendation for suitability. The Rubber Company cannot be held liable for any damage caused by incorrect installation. We hereby reserve the right to change the technical information herewith without notification or prior agreement.

Nitrile Rubber - Outer Rubber Skin Material Specification

Properties	Values
Polymer	Nitrile
Hardness (Shore A)	65° +/- 5°
Operating Temperature Range	-50°C to +120°C
Density (Specific Gravity)	1.30 kg/cm ³
Tensile Strength	7.0 MPa
Surface Finish	Cloth Moulded
Test Code	ISO 4100
Compound Resistance	Oil/Heat/Chemical/Weathering/Ozone
Tolerances	BS3734 BRMA

Open Cell Core Material Specification

Properties	Values
Polymer	Natural Rubber
Cell Structure	Open Cell
Hardness (Shore A)	10° / 18° (Average)
Operating Temperature Range	-40° to +70°C
Density (Specific Gravity)	420 kg/cm ³
Tensile Strength	295 Kpa
Compression Deflection (20% Deflection 70°C)	15% (Maximum)
Elongation at Break	235% - 250%
Accelerated Aging (Change in Compression Deflection at 70%)	+ / - 20%



The information contained on this product information sheet is to be used as guidance. The advice is given in good faith and does not constitute any guarantee or recommendation for suitability. The Rubber Company cannot be held liable for any damage caused by incorrect installation. We hereby reserve the right to change the technical information herewith without notification or prior agreement.