

Silicone U Channel Profile - 26mm x 20mm

Product Code: RCSRU26X20V

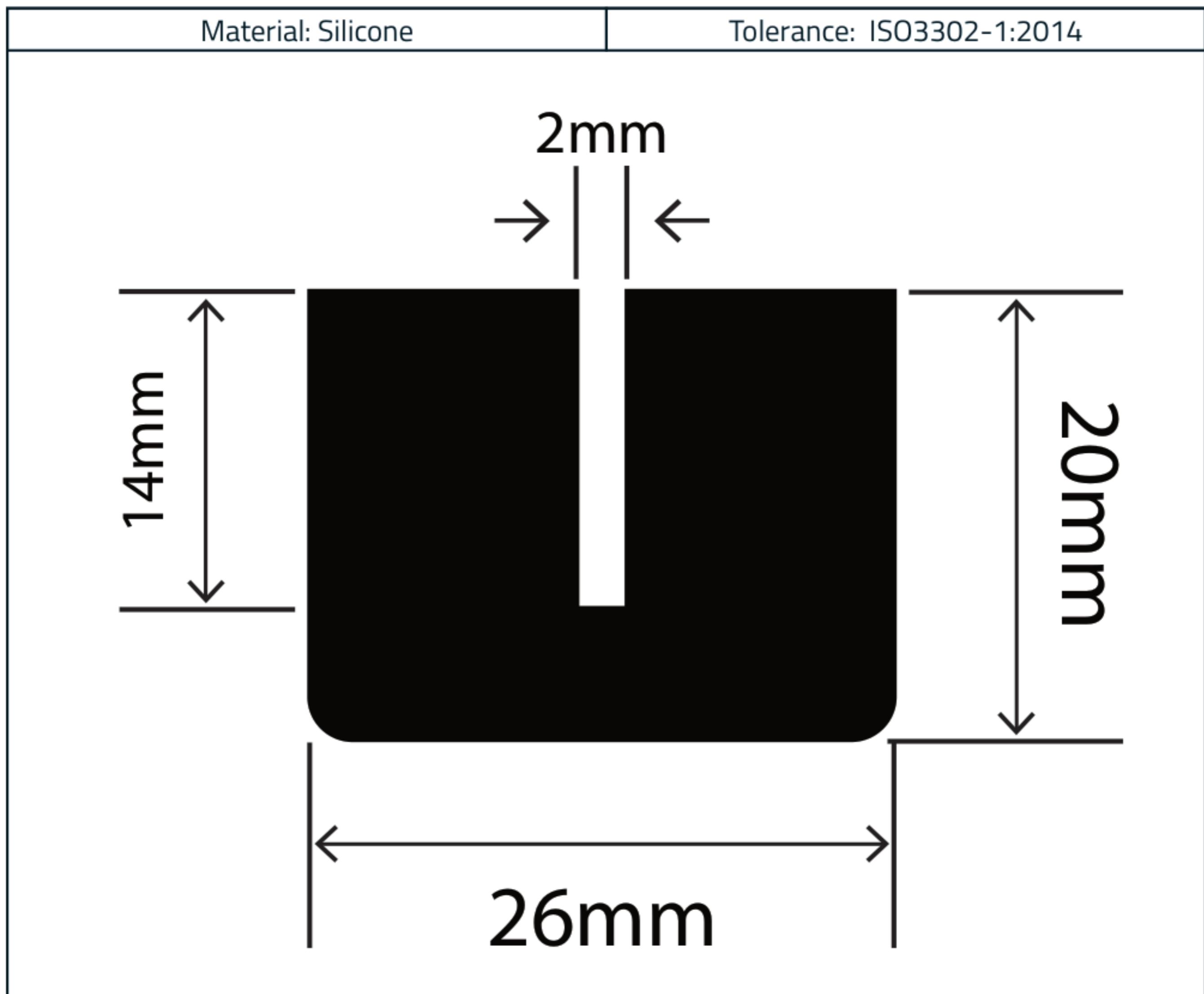

Measurements:

Height	Width
20mm	26mm

The information contained on this product information sheet is to be used as guidance. The advice is given in good faith and does not constitute any guarantee or recommendation for suitability. The Rubber Company cannot be held liable for any damage caused by incorrect installation. We hereby reserve the right to change the technical information herewith without notification or prior agreement.

Technical Data

Property	Test Method	Value
Hardness (Shore A)	DIN 53505	30° ±5°
Density (at 20°C)	ISO 1183-1A	1.10 g/cm ³
Tensile Strength	DIN 53504 S1 / ISO 37	9 N/mm ²
Elongation at Break	DIN 53504 S1	720%
Tear Resistance	ASTM D624 B	23 N/mm
Rebound Resilience	DIN 53512	52%
Compression Set (50% at 175°C for 22 hours)	DIN ISO 815-B	36%
Temperature Range (Working)	-	-50°C to +180°C
Temperature Range (Intermittent)	-	Up to 200°C



The information contained on this product information sheet is to be used as guidance. The advice is given in good faith and does not constitute any guarantee or recommendation for suitability. The Rubber Company cannot be held liable for any damage caused by incorrect installation. We hereby reserve the right to change the technical information herewith without notification or prior agreement.