

TPE Square U Channel - 17mm x 9mm

Product Code: RC150

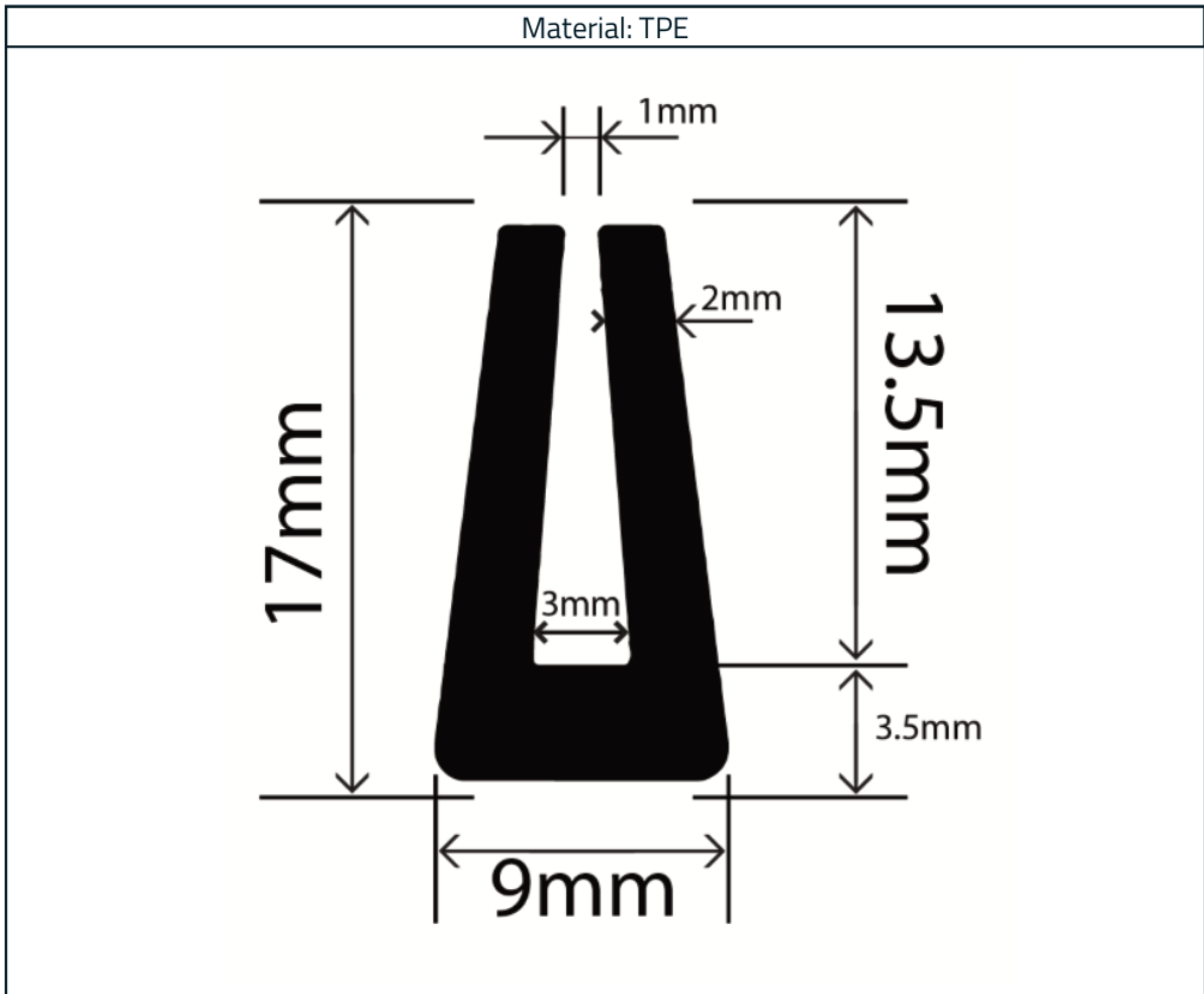

Measurements:

Height	Width
17mm	9mm

The information contained on this product information sheet is to be used as guidance. The advice is given in good faith and does not constitute any guarantee or recommendation for suitability. The Rubber Company cannot be held liable for any damage caused by incorrect installation. We hereby reserve the right to change the technical information herewith without notification or prior agreement.

Technical Data

Property	Test Method	Value
Shore Hardness	Shore A	67
Weight Per Metre	(gr)	108
Packaging Length	Metres	50
Minimum Operating Temperature	°C	-40
Maximum Operating Temperature	°C	+90
Sheet Thickness	mm	3.0
Minimum Bending Radius A	mm	100.0
Minimum Bending Radius B	mm	100.0
Minimum Bending Radius C	mm	100.0
Minimum Bending Radius D	mm	200.0
Bending Radius Thickness	mm	3.0

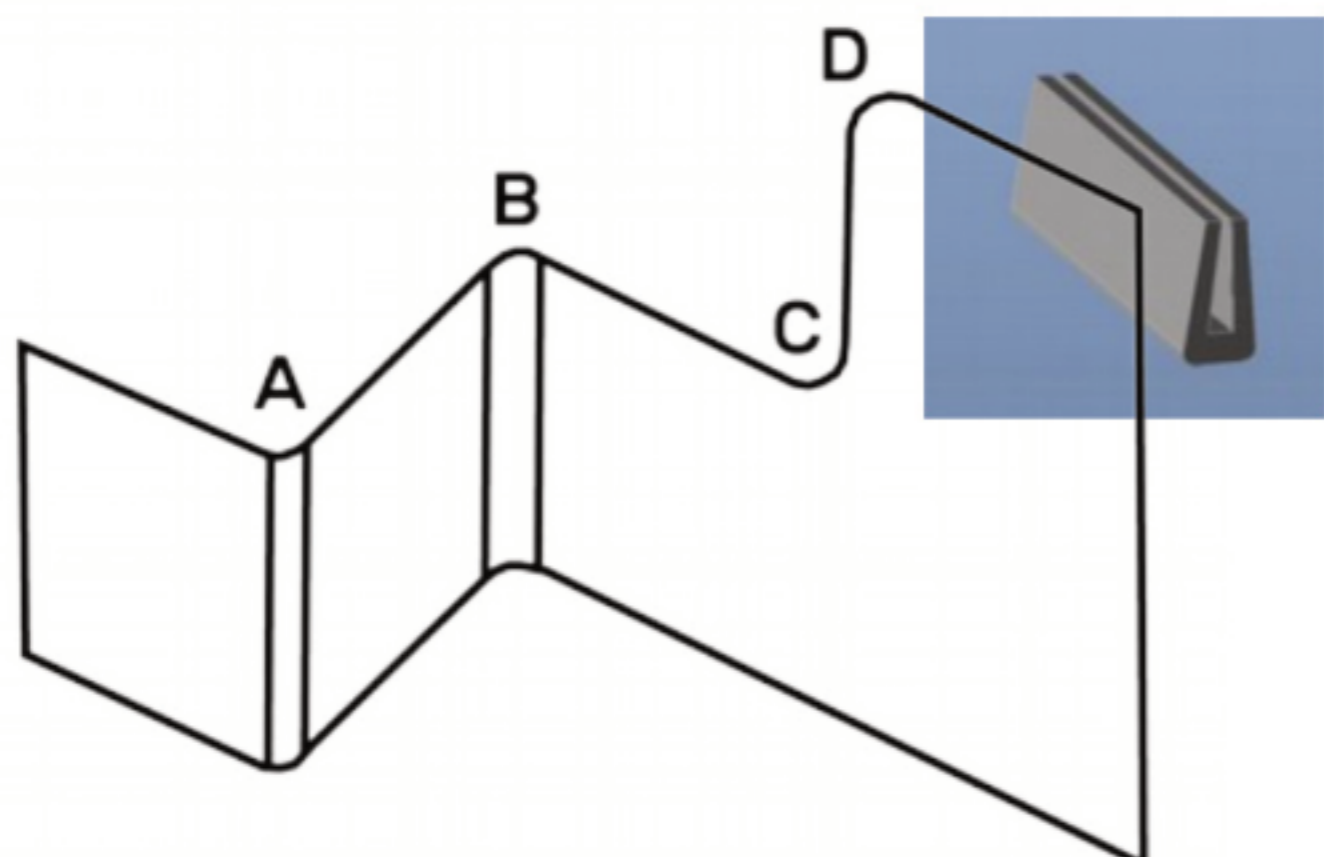

The information contained on this product information sheet is to be used as guidance. The advice is given in good faith and does not constitute any guarantee or recommendation for suitability. The Rubber Company cannot be held liable for any damage caused by incorrect installation. We hereby reserve the right to change the technical information herewith without notification or prior agreement.