

Silicone Square U Channel - 21mm x 11.5mm

Product Code: RC01138-6207

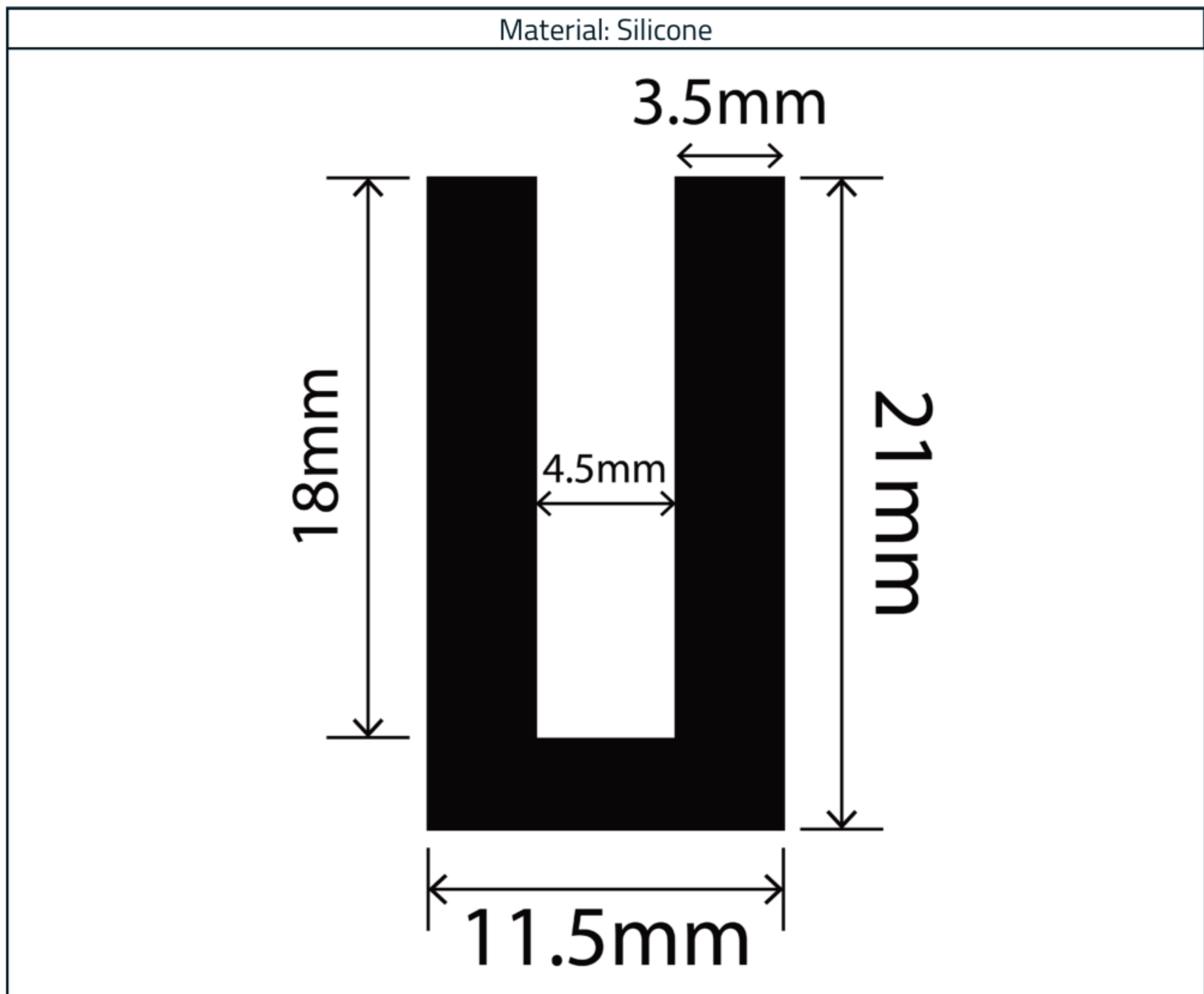

Measurements:

Height	Width
21mm	11.5mm

The information contained on this product information sheet is to be used as guidance. The advice is given in good faith and does not constitute any guarantee or recommendation for suitability. The Rubber Company cannot be held liable for any damage caused by incorrect installation. We hereby reserve the right to change the technical information herewith without notification or prior agreement.

Technical Data

Property	Test Method	Value
Temperature Range	-	-50°C to +180°C (working) up to +200°C (intermittent)
Appearance	-	Transparent
Density at 20°C	ISO 1183-1 A	Approx. 1.15 g/cm ³
Hardness (Shore A)	DIN 53505	52
Tensile Strength	DIN 53504 S1 / ISO 37	11 N/mm ²
Elongation at Break	DIN 53504 S1	520%
Tear Strength	ASTM D 624 B	25 N/mm
Rebound Resilience	DIN 53512	56%
Compression Set	DIN ISO815-B (22h/175°C)	34%

Features:

- FDA Compliant to 21 CFR 177.2600
- WRc approved to M103580/A-H
- Compliant to EC1935/2004
- BfR compliance chapter XV
- Certified to USP Class VI
- Free from Phthalate
- Free from TSE/BSE bi-products



The information contained on this product information sheet is to be used as guidance. The advice is given in good faith and does not constitute any guarantee or recommendation for suitability. The Rubber Company cannot be held liable for any damage caused by incorrect installation. We hereby reserve the right to change the technical information herewith without notification or prior agreement.