

Silicone Square U Channel - 33.5mm x 20mm

Product Code: RC01138-3848

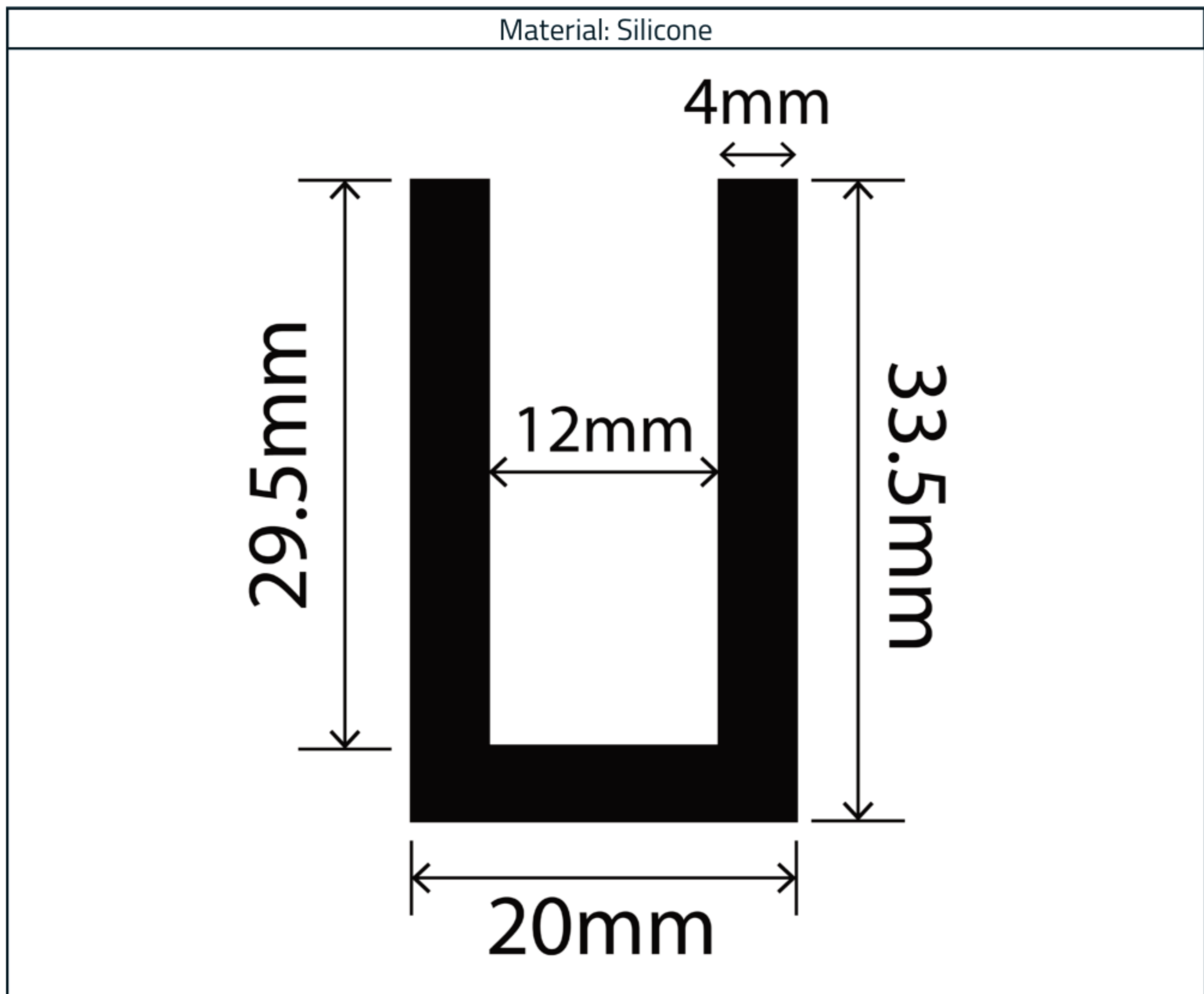

Measurements:

| Height | Width |
|--------|-------|
| 33.5mm | 20mm |

The information contained on this product information sheet is to be used as guidance. The advice is given in good faith and does not constitute any guarantee or recommendation for suitability. The Rubber Company cannot be held liable for any damage caused by incorrect installation. We hereby reserve the right to change the technical information herewith without notification or prior agreement.

Technical Data

| Property | Test Method | Value |
|---------------------|--------------------------|---|
| Temperature Range | - | -50°C to +180°C (working) up to +200°C (intermittent) |
| Appearance | - | Transparent |
| Density at 20°C | ISO 1183-1 A | Approx. 1.15 g/cm ³ |
| Hardness (Shore A) | DIN 53505 | 61 |
| Tensile Strength | DIN 53504 S1 / ISO 37 | 11 N/mm ² |
| Elongation at Break | DIN 53504 S1 | 440% |
| Tear Strength | ASTM D 624 B | 24 N/mm |
| Rebound Resilience | DIN 53512 | 57% |
| Compression Set | DIN ISO815-B (22h/175°C) | 31% |

Features:

- FDA Compliant to 21 CFR 177.2600
- WRc approved to M103580/A-H
- Compliant to EC1935/2004
- BfR compliance chapter XV
- Certified to USP Class VI
- Free from Phthalate
- Free from TSE/BSE bi-products



The information contained on this product information sheet is to be used as guidance. The advice is given in good faith and does not constitute any guarantee or recommendation for suitability. The Rubber Company cannot be held liable for any damage caused by incorrect installation. We hereby reserve the right to change the technical information herewith without notification or prior agreement.