

Rubber P Extrusion

Product Code: RC01107

Reference: RC858

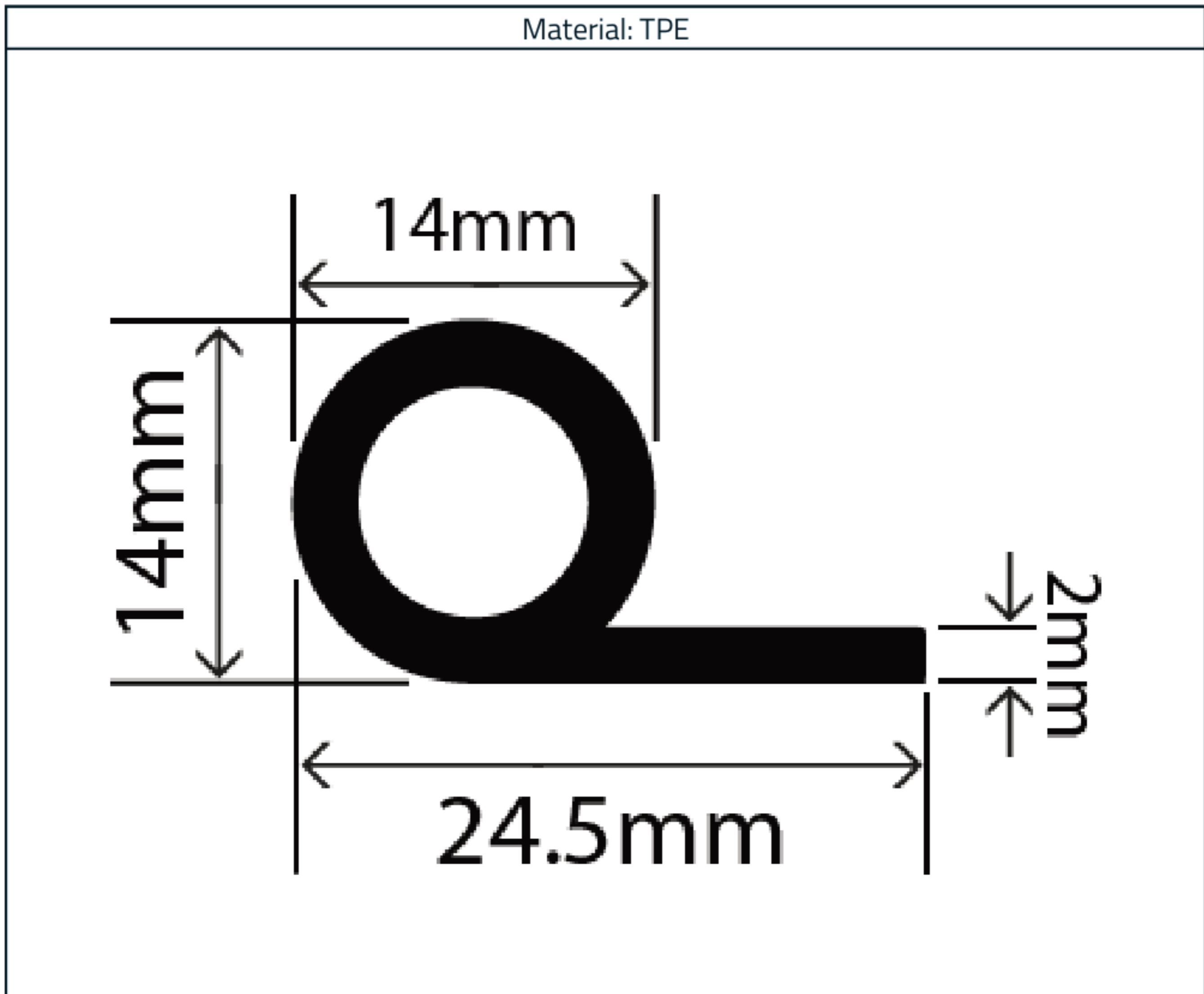

Measurements:

Bead Diameter
Ø14mm

The information contained on this product information sheet is to be used as guidance. The advice is given in good faith and does not constitute any guarantee or recommendation for suitability. The Rubber Company cannot be held liable for any damage caused by incorrect installation. We hereby reserve the right to change the technical information herewith without notification or prior agreement.

Technical Data

Specification	Value
Hardness	72shA
Tensile Strength	7.4 MPA
Elongation at break	450%
Density	0.97
Compression Set (22 hours, 70 °C)	30%
Working Temperature Range	-50 °C to +90 °C



The information contained on this product information sheet is to be used as guidance. The advice is given in good faith and does not constitute any guarantee or recommendation for suitability. The Rubber Company cannot be held liable for any damage caused by incorrect installation. We hereby reserve the right to change the technical information herewith without notification or prior agreement.