

EPDM Sponge Profile

Product Code: RC-S107

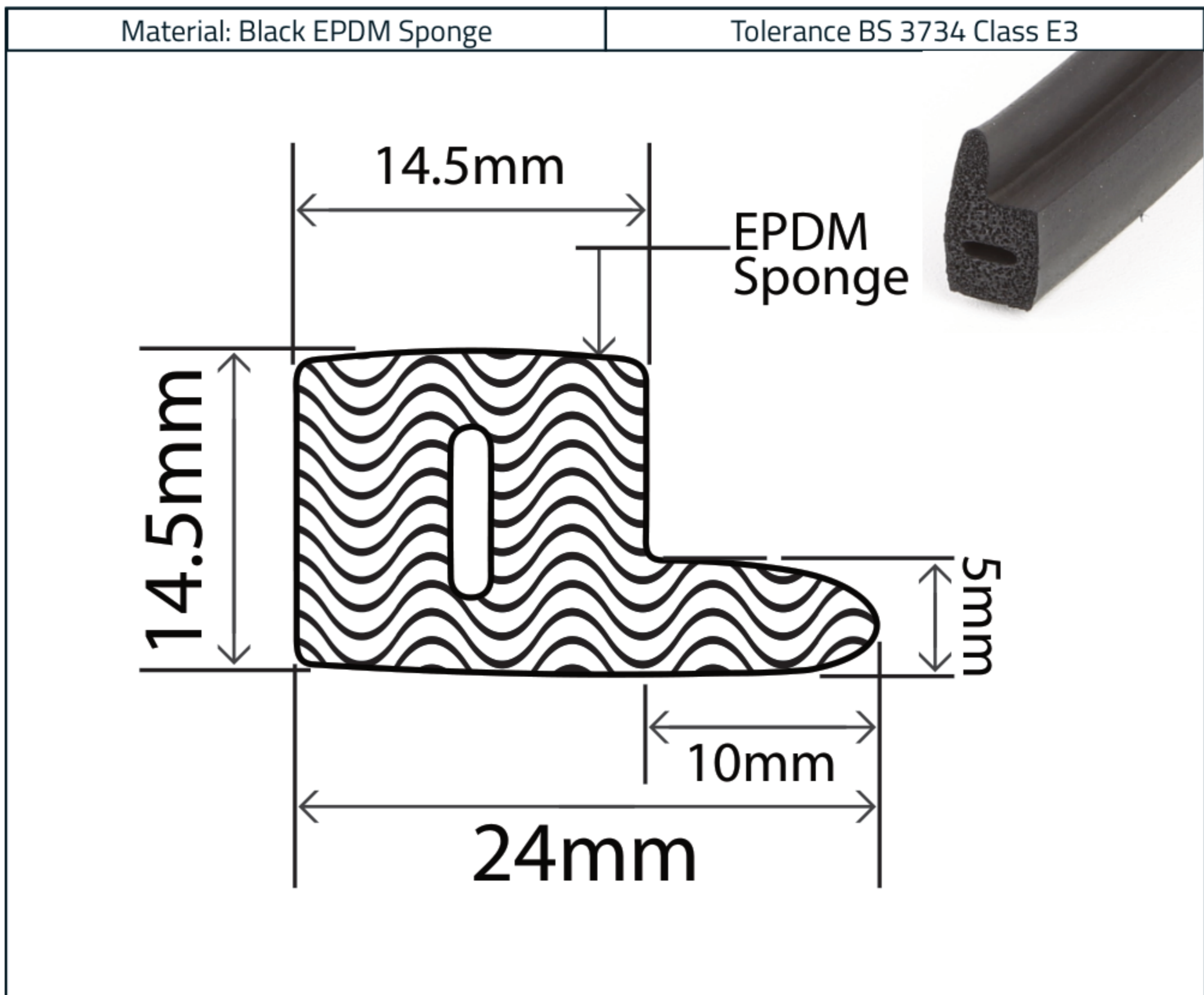

Details:

1. Sold by either the coil or the metre
2. This product's coil length is 50 metres
3. This product's weight per metre is 0.11 kg
4. This product is made of a flexible sponge material therefore sizes are approximations.

The information contained on this product information sheet is to be used as guidance. The advice is given in good faith and does not constitute any guarantee or recommendation for suitability. The Rubber Company cannot be held liable for any damage caused by incorrect installation. We hereby reserve the right to change the technical information herewith without notification or prior agreement.

Technical Data

Specification	Value
Material	EPDM Sponge
Density Range	0.5 - 0.9 gm/cm ³
Oven Ageing (7 days, 70°C)	±30%
Water Absorption	5% Maximum
Compression (24 hours recovery)	25% Maximum
Ozone Resistance	Excellent
Weather Resistance	Excellent
Low Temperature Flexibility (-40°C)	Pass
UV Light Resistance	Excellent
Mould Growth Resistance	Very Good



The information contained on this product information sheet is to be used as guidance. The advice is given in good faith and does not constitute any guarantee or recommendation for suitability. The Rubber Company cannot be held liable for any damage caused by incorrect installation. We hereby reserve the right to change the technical information herewith without notification or prior agreement.