

**D Profile - 60mm x 100mm**

Product Code: RCHD100X60L

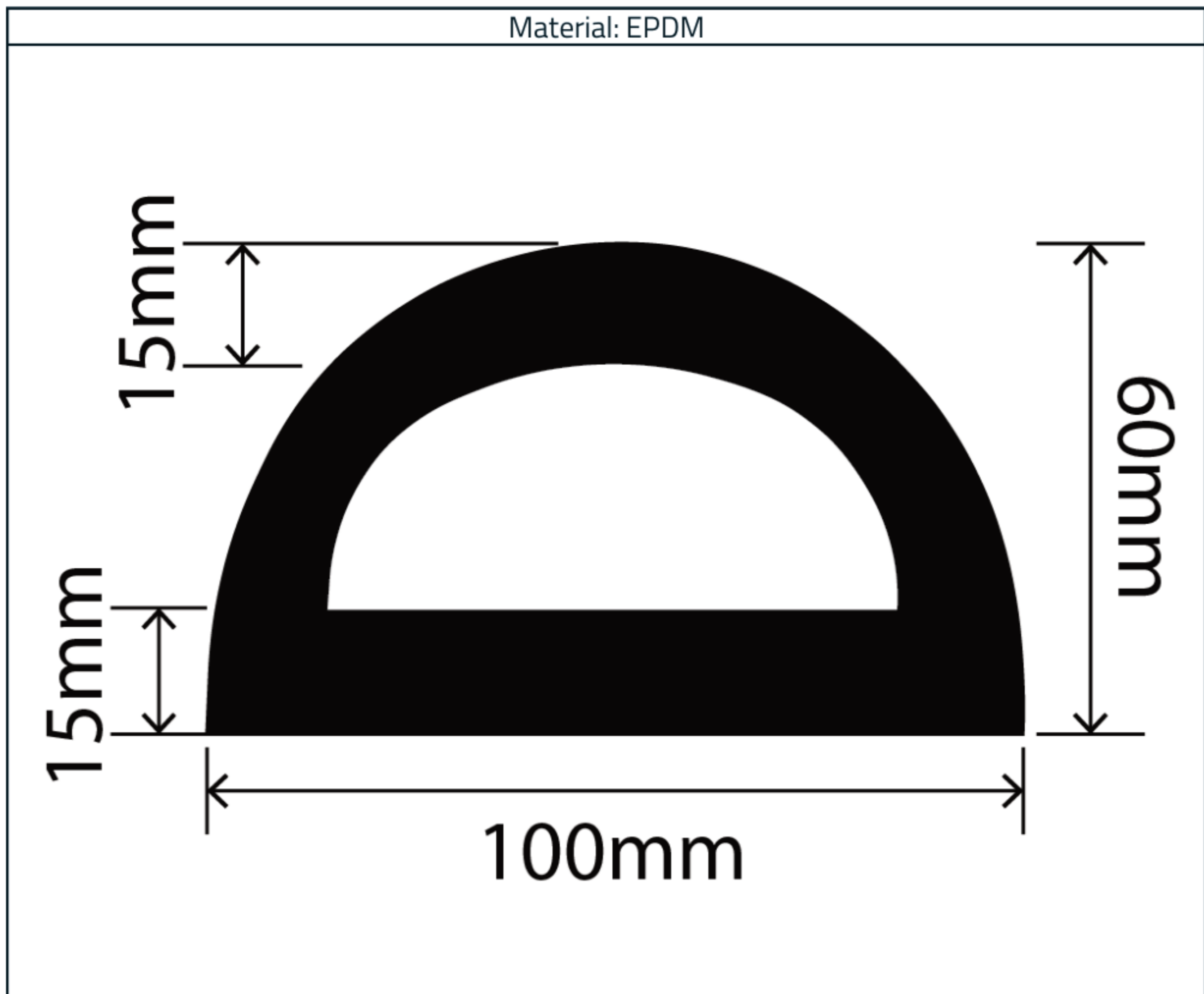

**Measurements:**

Height	Width
60mm	100mm

The information contained on this product information sheet is to be used as guidance. The advice is given in good faith and does not constitute any guarantee or recommendation for suitability. The Rubber Company cannot be held liable for any damage caused by incorrect installation. We hereby reserve the right to change the technical information herewith without notification or prior agreement.

### Technical Data

Property	Value
<b>Initial Properties</b>	
Hardness (Shore A)	70°
Density (Specific Gravity)	1.26 g/cm <sup>3</sup>
Tensile Strength	9.0 Mpa
Elongation at Break	275%
Compression Set (22hrs @ 70°C)	22.5%
<b>Heat Resistance (70hrs @ 70°C)</b>	
Change in Shore Hardness	+5°
Change in Tensile Strength	± 10%
Change in Elongation at Break	± 15%
<b>Resistance</b>	
Ozone & Weathering Resistance	Fair
Dilute Acid & Bases	Fair

The values above are typical values for these compounds but must not be taken and used as material specification.



The information contained on this product information sheet is to be used as guidance. The advice is given in good faith and does not constitute any guarantee or recommendation for suitability. The Rubber Company cannot be held liable for any damage caused by incorrect installation. We hereby reserve the right to change the technical information herewith without notification or prior agreement.