

### Silicone Trapezium Profile - 9.5mm x 7.5mm

Product Code: RCTR9.5X7.5V

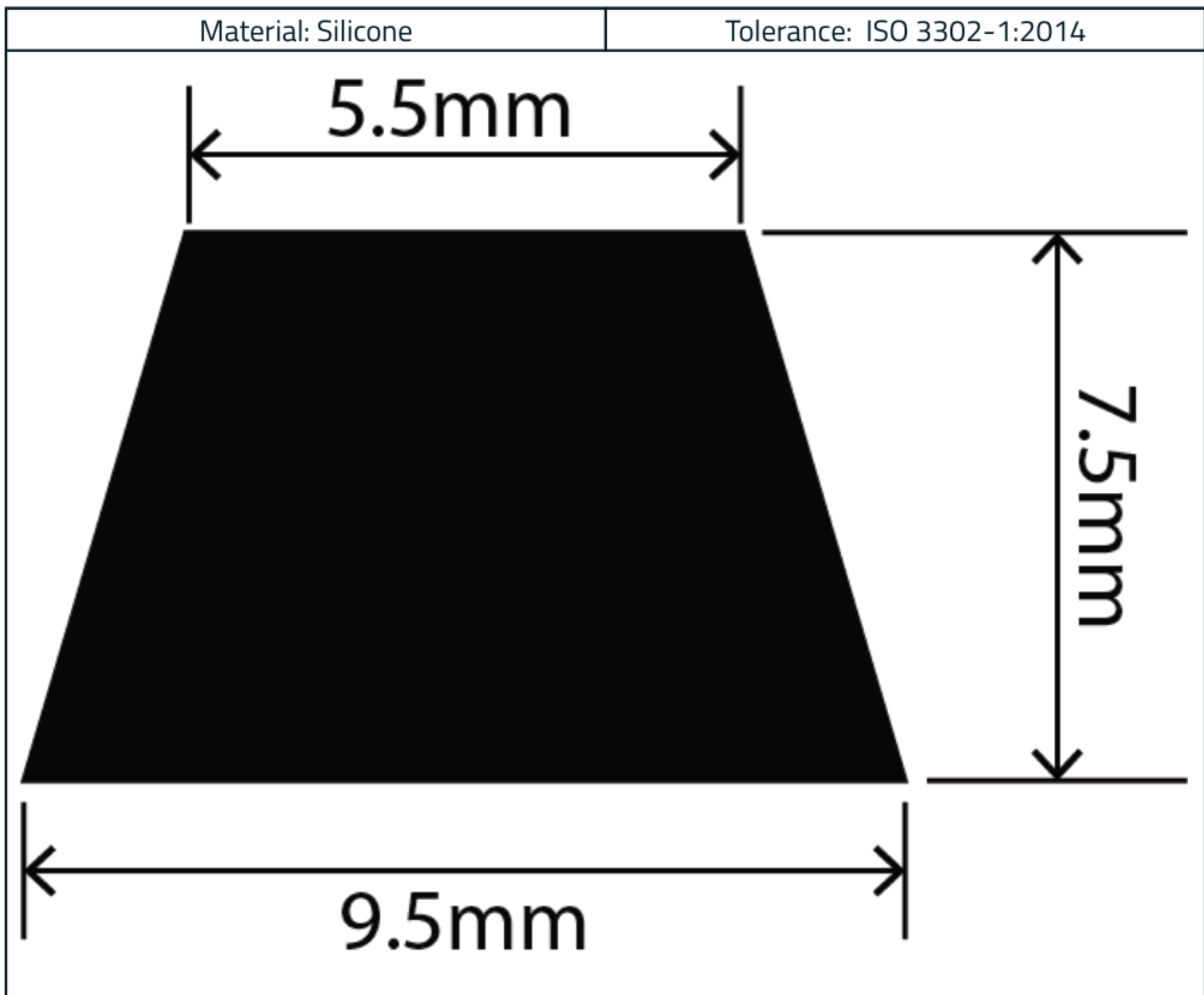

#### Measurements:

Height	Width
7.5mm	9.5mm

The information contained on this product information sheet is to be used as guidance. The advice is given in good faith and does not constitute any guarantee or recommendation for suitability. The Rubber Company cannot be held liable for any damage caused by incorrect installation. We hereby reserve the right to change the technical information herewith without notification or prior agreement.

### Technical Data

Property	Test Method	Value
Temperature Range		-50°C to + 180°C (working) Up to 200°C (intermittent)
Appearance		Transparent
Density at 20°C	ISO 1183-1 A	Approx. 1.15 g/cm <sup>3</sup>
Hardness Shore A	DIN 53505	61
Tensile Strength	DIN 53504 S1 / ISO 37	11.00 N/mm <sup>2</sup>
Elongation at Break	DIN 53504 S 1	440%
Tear Strength	ASTM D 624 B	24 N/mm
Rebound Resilience	DIN 53512	57%
Compression Set	DIN ISO815-B (22h / 175°C)	31%



The information contained on this product information sheet is to be used as guidance. The advice is given in good faith and does not constitute any guarantee or recommendation for suitability. The Rubber Company cannot be held liable for any damage caused by incorrect installation. We hereby reserve the right to change the technical information herewith without notification or prior agreement.