

Hollow Silicone P Profile 56mm x 13mm

Product Code: RCSP56X2V

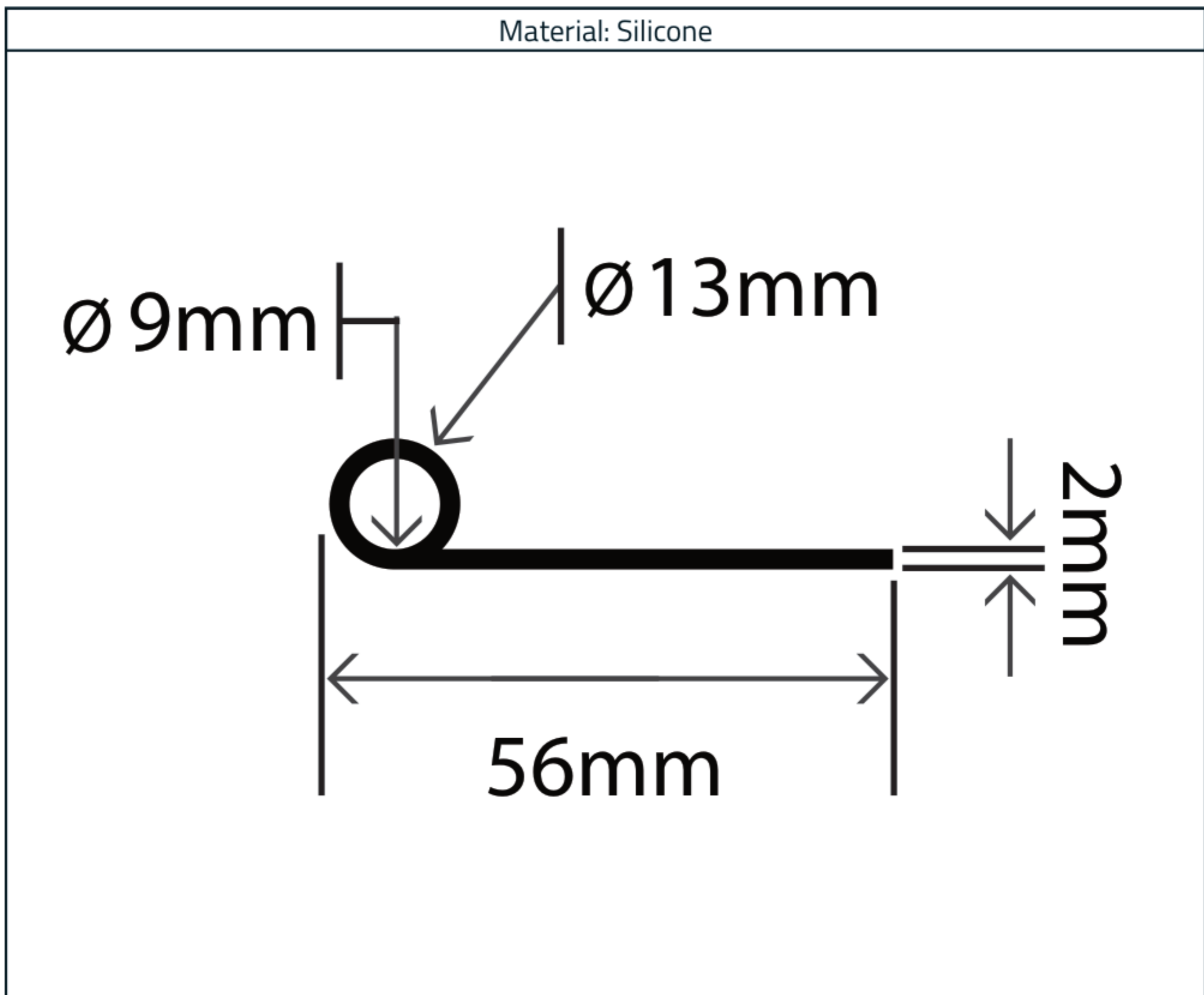

Measurements:

Height	Width	Bead Inner Diameter
13mm	56mm	9mm

The information contained on this product information sheet is to be used as guidance. The advice is given in good faith and does not constitute any guarantee or recommendation for suitability. The Rubber Company cannot be held liable for any damage caused by incorrect installation. We hereby reserve the right to change the technical information herewith without notification or prior agreement.

Technical Data

This profile is manufactured from our general-purpose silicone compound, which provides very good mechanical properties in a variety of applications. It also features excellent heat stability across a broad temperature range. This compound has good flexibility and is easily pigmented into a variety of colours.

Material Specification

Properties	Test Method	Values
Polymer	-	Silicone
Hardness (Shore A)	DIN 53505	61° +/- 5°
Density (@ 20°C)	ISO 1183-1 A	Approx. 1.15 g/cm ³
Tensile Strength	ISO 37	11.00 N/mm ²
Elongation at Break	DIN 53504 S 1	440%
Tear Resistance	ASTM D 624 B	24 N/mm
Rebound Resilience	DIN 53512	57%
Compression Set (22rs @ 175°C)	DIN ISO 815-B	31%
Temperature Range (Working)	-	-50°C to +180°C
Temperature Range (Intermittent)	-	+200°C



The information contained on this product information sheet is to be used as guidance. The advice is given in good faith and does not constitute any guarantee or recommendation for suitability. The Rubber Company cannot be held liable for any damage caused by incorrect installation. We hereby reserve the right to change the technical information herewith without notification or prior agreement.