

Hollow Silicone P Profile 26.5mm x 13mm

Product Code: RCSP26.5X2SR

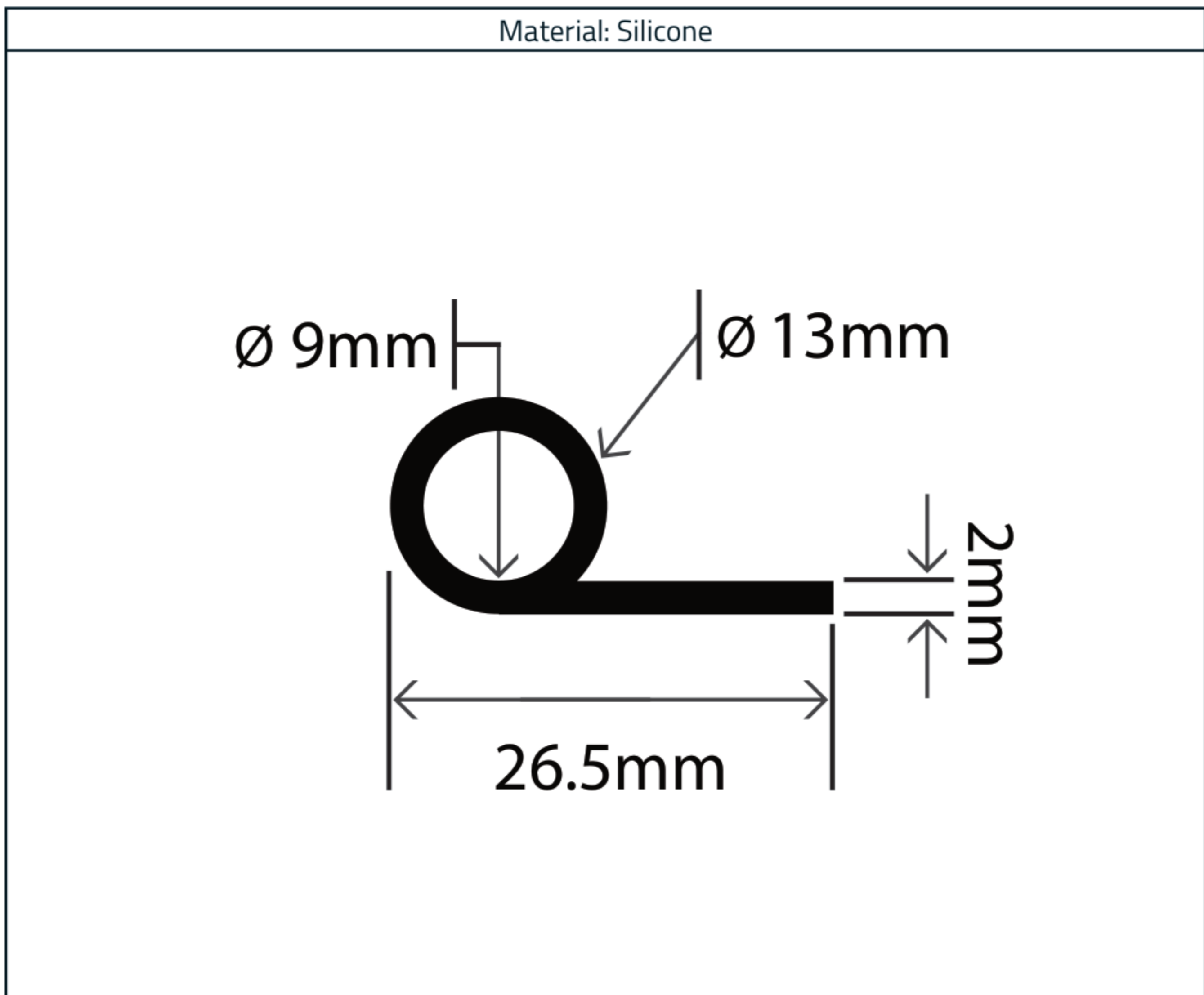

Measurements:

Height	Width	Bead Inner Diameter
13mm	26.5mm	9mm

The information contained on this product information sheet is to be used as guidance. The advice is given in good faith and does not constitute any guarantee or recommendation for suitability. The Rubber Company cannot be held liable for any damage caused by incorrect installation. We hereby reserve the right to change the technical information herewith without notification or prior agreement.

Technical Data

This profile can be manufactured from a variety of general purpose silicone rubber grades as standard. All of the available grades feature excellent stability and physical properties. This profile can be supplied either pigmented or transparent.

Temperature Range (Working)

-65°C to +200°C

Material Specification - 40° Shore

Properties	Tested Method	Values
Polymer	-	Silicone
Hardness (Shore A)	DIN 53505	40° +/- 5°
Density (Specific Gravity)	DIN 53 479A	1.12 g/cm ³
Tensile Strength	DIN 53504-SI	9.3 N/mm ²
Elongation at Break	DIN 53504-SI	570%
Tear Resistance	ASTM D 624 B	16 N/mm
Impact Resistance	DIN 53512	57%
Compression Set (22rs @ 175°C)	DIN 53517	35%

Material Specification - 50° Shore

Properties	Tested Method	Values
Polymer	-	Silicone
Hardness (Shore A)	DIN 53505	50° +/- 5°
Density (Specific Gravity)	DIN 53 479A	1.14 g/cm ³
Tensile Strength	DIN 53504-SI	10.4 N/mm ²
Elongation at Break	DIN 53504-SI	500%
Tear Resistance	ASTM D 624 B	21 N/mm
Impact Resistance	DIN 53512	54%
Compression Set (22rs @ 175°C)	DIN 53517	35%

The information contained on this product information sheet is to be used as guidance. The advice is given in good faith and does not constitute any guarantee or recommendation for suitability. The Rubber Company cannot be held liable for any damage caused by incorrect installation. We hereby reserve the right to change the technical information herewith without notification or prior agreement.

Material Specification - 60° Shore

Properties	Tested Method	Values
Polymer	-	Silicone
Hardness (Shore A)	DIN 53505	60° +/- 5°
Density (Specific Gravity)	DIN 53 479A	1.15 g/cm ³
Tensile Strength	DIN 53504-SI	10.4 N/mm ²
Elongation at Break	DIN 53504-SI	470%
Tear Resistance	ASTM D 624 B	21 N/mm
Impact Resistance	DIN 53512	58%
Compression Set (22rs @ 175°C)	DIN 53517	35%

Material Specification - 70° Shore

Properties	Tested Method	Values
Polymer	-	Silicone
Hardness (Shore A)	DIN 53505	70° +/- 5°
Density (Specific Gravity)	DIN 53 479A	1.17 g/cm ³
Tensile Strength	DIN 53504-SI	10.7 N/mm ²
Elongation at Break	DIN 53504-SI	440%
Tear Resistance	ASTM D 624 B	22 N/mm
Impact Resistance	DIN 53512	56%
Compression Set (22rs @ 175°C)	DIN 53517	35%

Material Specification - 80° Shore

Properties	Tested Method	Values
Polymer	-	Silicone
Hardness (Shore A)	DIN 53505	80° +/- 5°
Density (Specific Gravity)	DIN 53 479A	1.19 g/cm ³
Tensile Strength	DIN 53504-SI	9.6 N/mm ²
Elongation at Break	DIN 53504-SI	350%
Tear Resistance	ASTM D 624 B	21 N/mm
Impact Resistance	DIN 53512	54%
Compression Set (22rs @ 175°C)	DIN 53517	40%

The information contained on this product information sheet is to be used as guidance. The advice is given in good faith and does not constitute any guarantee or recommendation for suitability. The Rubber Company cannot be held liable for any damage caused by incorrect installation. We hereby reserve the right to change the technical information herewith without notification or prior agreement.