

Hollow Silicone P Profile 22mm x 5.1mm

Product Code: RCSP22X1.6V

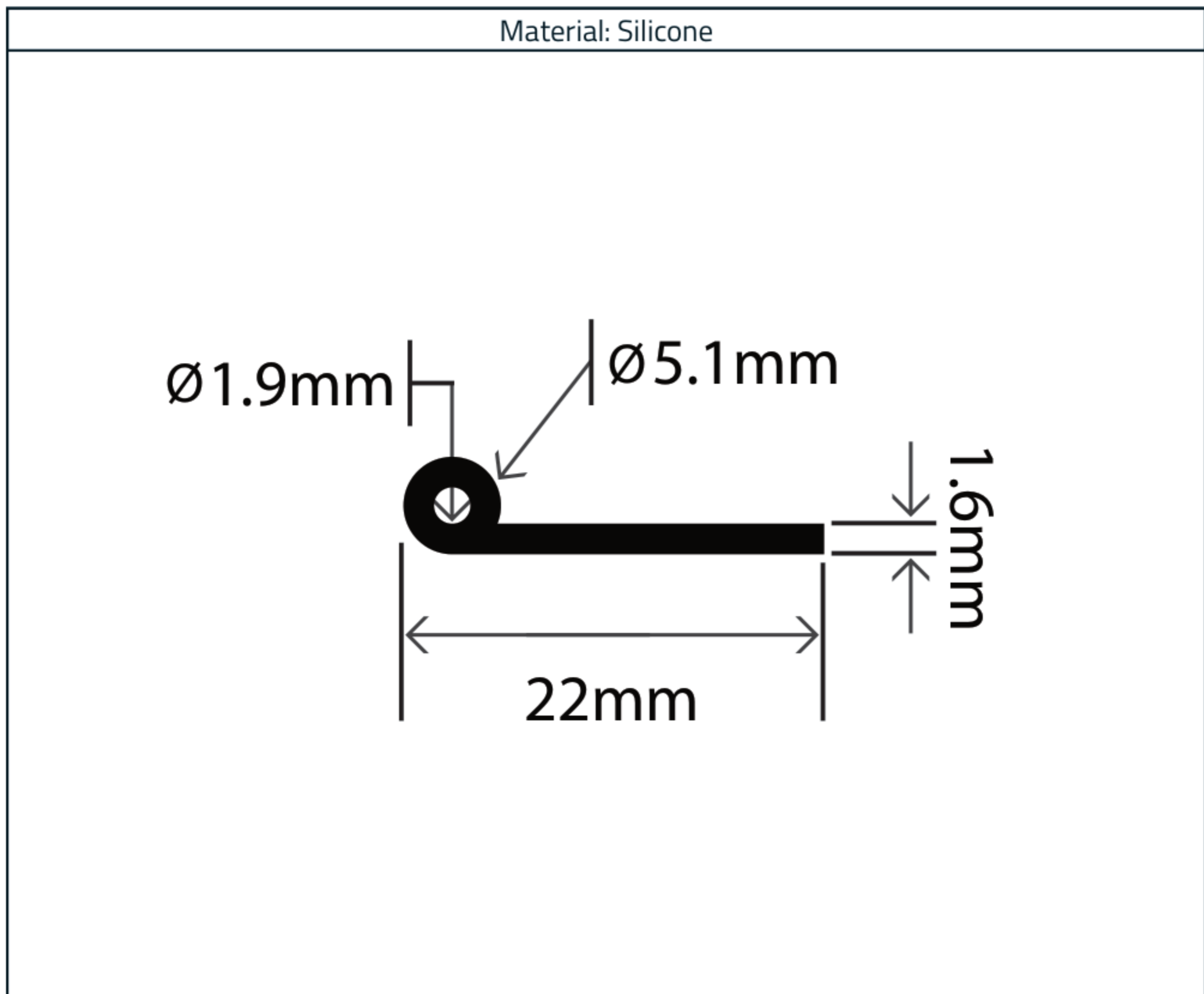

Measurements:

| Height | Width | Bead Inner Diameter |
|--------|-------|---------------------|
| 5.1mm | 22mm | 1.9mm |

The information contained on this product information sheet is to be used as guidance. The advice is given in good faith and does not constitute any guarantee or recommendation for suitability. The Rubber Company cannot be held liable for any damage caused by incorrect installation. We hereby reserve the right to change the technical information herewith without notification or prior agreement.

Technical Data

This profile is manufactured from our general-purpose silicone compound, which provides very good mechanical properties in a variety of applications. It also features excellent heat stability across a broad temperature range. This compound has good flexibility and is easily pigmented into a variety of colours.

Material Specification

| Properties | Test Method | Values |
|----------------------------------|---------------|--------------------------------|
| Polymer | - | Silicone |
| Hardness (Shore A) | DIN 53505 | 61° +/- 5° |
| Density (@ 20°C) | ISO 1183-1 A | Approx. 1.15 g/cm ³ |
| Tensile Strength | ISO 37 | 11.00 N/mm ² |
| Elongation at Break | DIN 53504 S 1 | 440% |
| Tear Resistance | ASTM D 624 B | 24 N/mm |
| Rebound Resilience | DIN 53512 | 57% |
| Compression Set (22rs @ 175°C) | DIN ISO 815-B | 31% |
| Temperature Range (Working) | - | -50°C to +180°C |
| Temperature Range (Intermittent) | - | +200°C |



The information contained on this product information sheet is to be used as guidance. The advice is given in good faith and does not constitute any guarantee or recommendation for suitability. The Rubber Company cannot be held liable for any damage caused by incorrect installation. We hereby reserve the right to change the technical information herewith without notification or prior agreement.