

Hollow Silicone P Profile 21mm x 9.1mm

Product Code: RCSP21X1.1V

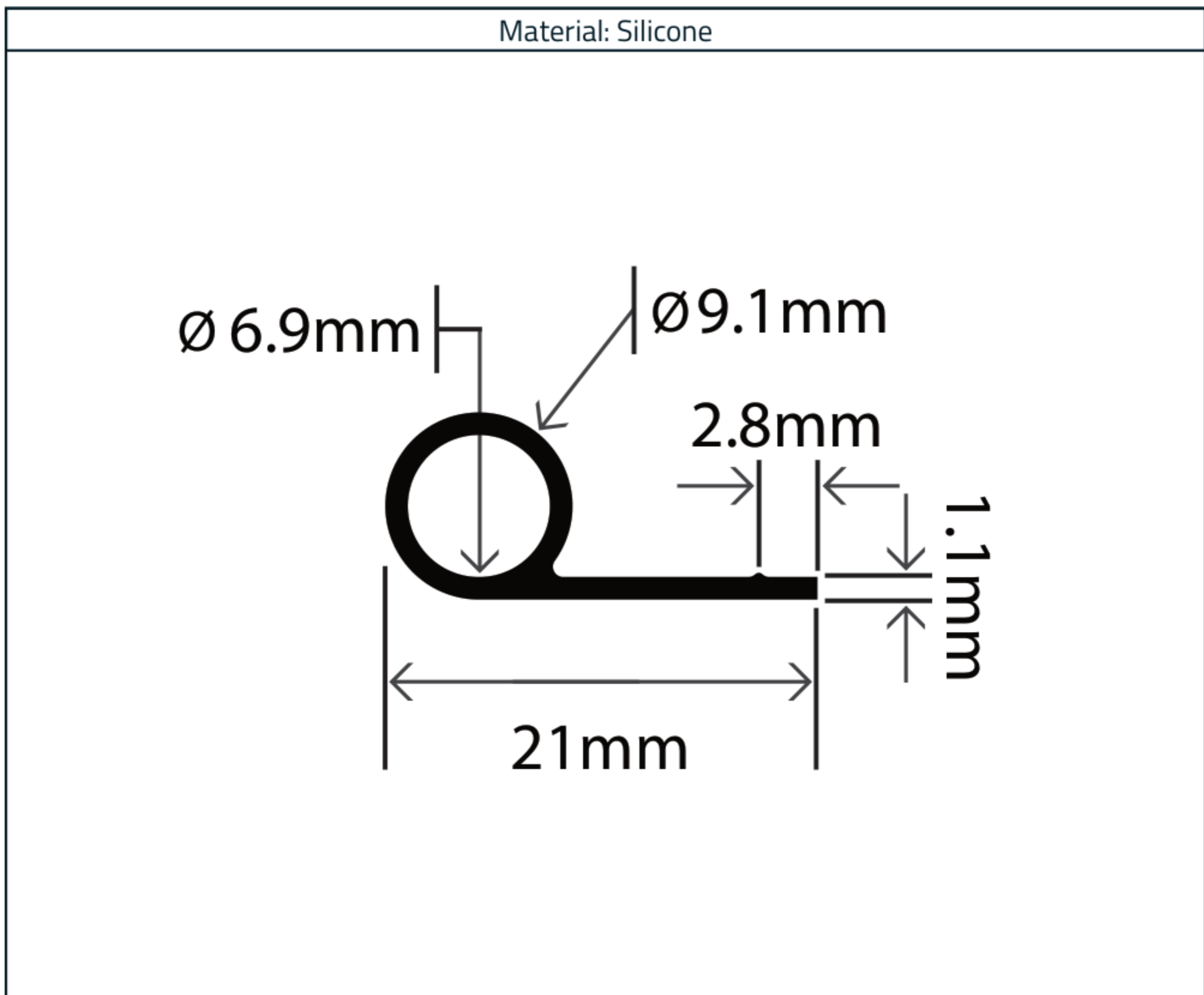

Measurements:

Height	Width	Bead Inner Diameter
9.1mm	21mm	6.9mm

The information contained on this product information sheet is to be used as guidance. The advice is given in good faith and does not constitute any guarantee or recommendation for suitability. The Rubber Company cannot be held liable for any damage caused by incorrect installation. We hereby reserve the right to change the technical information herewith without notification or prior agreement.

Technical Data

This profile is manufactured from our general-purpose silicone compound, which provides very good mechanical properties in a variety of applications. It also features excellent heat stability across a broad temperature range. This compound has good flexibility and is easily pigmented into a variety of colours.

Material Specification

Properties		Values
Polymer	-	Silicone
Hardness (Shore A)	DIN 53505	32° +/- 5°
Density (@ 20°C)	ISO 1183-1 A	Approx. 1.10 g/cm ³
Tensile Strength	ISO 37	9.00 N/mm ²
Elongation at Break	DIN 53504 S 1	720%
Tear Resistance	ASTM D 624 B	23 N/mm
Rebound Resilience	DIN 53512	52%
Compression Set (22rs @ 175°C)	DIN ISO 815-B	36%
Temperature Range (Working)	-	-50°C to +180°C
Temperature Range (Intermittent)	-	+200°C



The information contained on this product information sheet is to be used as guidance. The advice is given in good faith and does not constitute any guarantee or recommendation for suitability. The Rubber Company cannot be held liable for any damage caused by incorrect installation. We hereby reserve the right to change the technical information herewith without notification or prior agreement.