

Hollow Silicone D Profile RCSHD12X13S

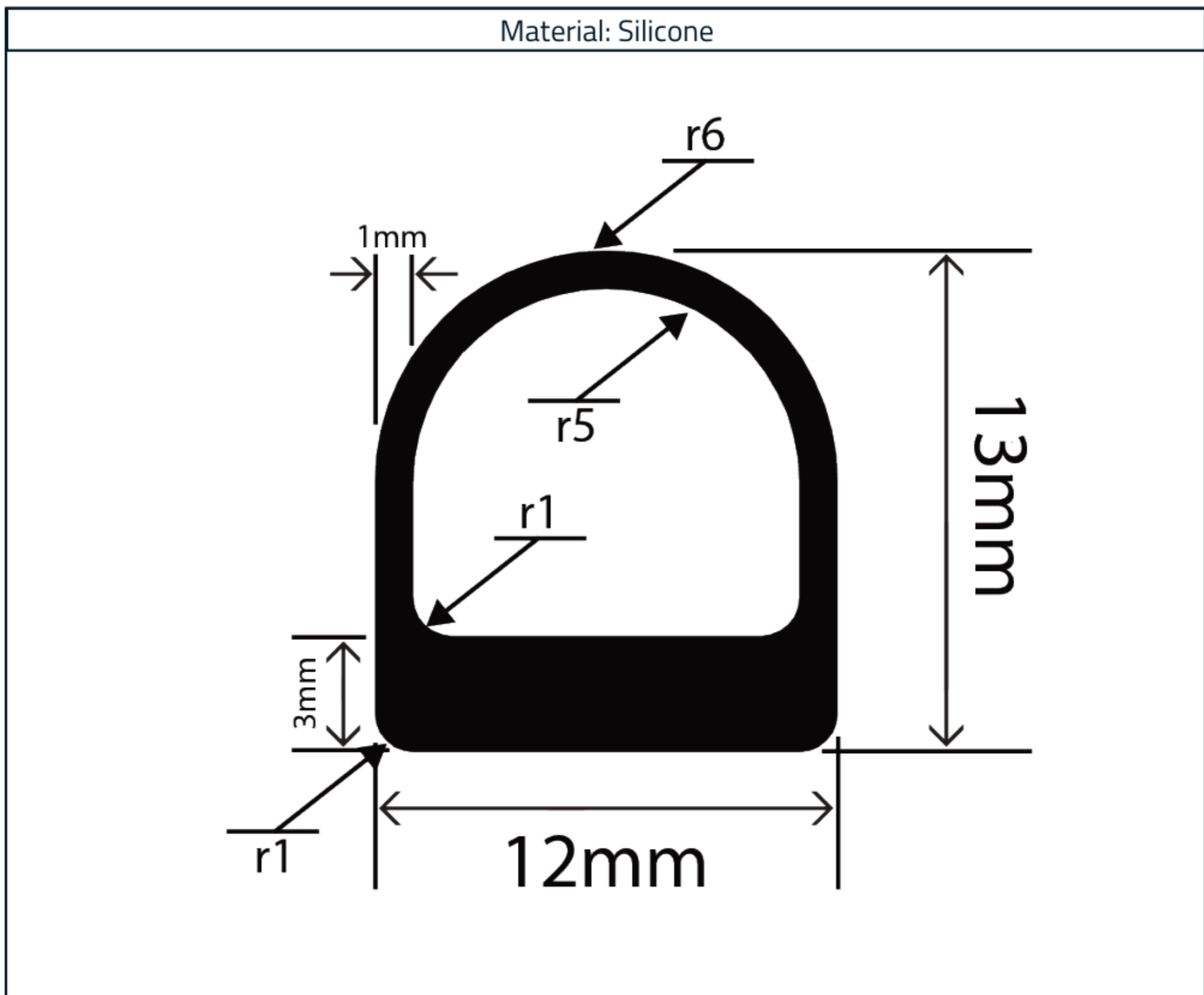

Measurements:

Height	Width
13mm	12mm

The information contained on this product information sheet is to be used as guidance. The advice is given in good faith and does not constitute any guarantee or recommendation for suitability. The Rubber Company cannot be held liable for any damage caused by incorrect installation. We hereby reserve the right to change the technical information herewith without notification or prior agreement.

Technical Data

Material Specification

Properties	Values
Polymer	Silicone
Hardness (Shore A)	70
Density (Specific Gravity)	Approx. 1.18 g/cm ³
Tensile Strength	11 N/mm ²
Compression Set (20% Deflection at 70°C)	40%
Elongation at Break	440%



The information contained on this product information sheet is to be used as guidance. The advice is given in good faith and does not constitute any guarantee or recommendation for suitability. The Rubber Company cannot be held liable for any damage caused by incorrect installation. We hereby reserve the right to change the technical information herewith without notification or prior agreement.