

EPDM Hollow D Profile 90mm x 65mm

Product Code: RCHD90X65W

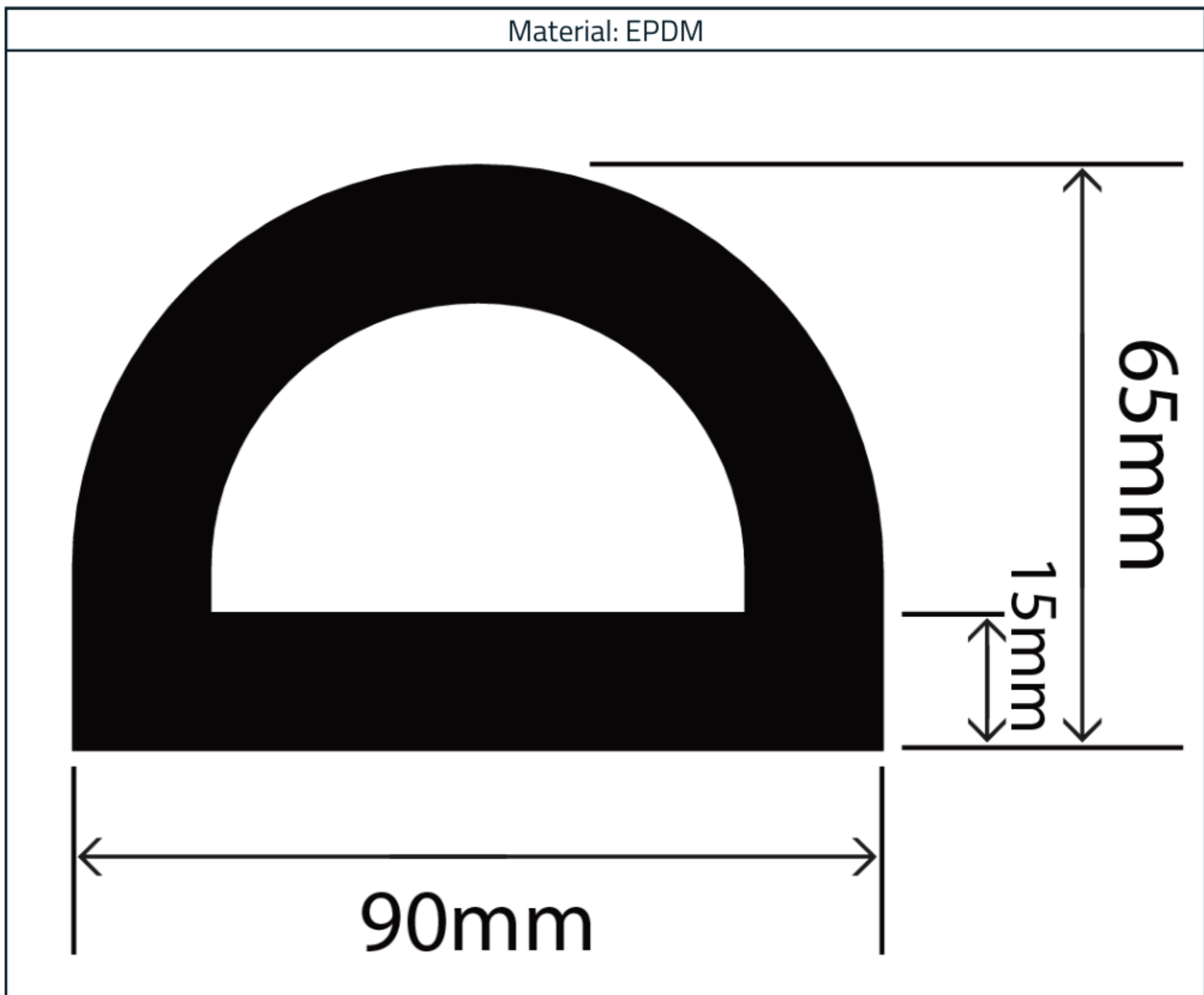

Measurements:

| Height | Width |
|--------|-------|
| 65mm | 90mm |

The information contained on this product information sheet is to be used as guidance. The advice is given in good faith and does not constitute any guarantee or recommendation for suitability. The Rubber Company cannot be held liable for any damage caused by incorrect installation. We hereby reserve the right to change the technical information herewith without notification or prior agreement.

Technical Data

This extrusion is manufactured using an EPDM based, nitrosamine safe, sulphur cured extrusion compound. Although this compound is not designed to meet any particular specification it does conform to ASTM D2000 M2BA707 A14, B13, C12 and F17 specifications.

EPDM generally provides excellent resistance to weathering, UV and Ozone deterioration. It also provides good resistance to polar substances, solvents and water.

Material Specification

| Properties | | Values |
|--------------------------------|----------|------------------------------|
| Polymer | - | EPDM |
| Hardness (IRHD) | ISO 48 | 72° +/- 5° |
| Hardness (Shore A) | ISO 868 | 70° +/- 5° |
| Density (Specific Gravity) | ISO 1183 | 1.26 g/cm ³ +/- 2 |
| Tensile Strength | ISO 37 | 7.0 MPa (min) |
| Elongation at Break | ISO 37 | 300% (min) |
| Compression Set (24hrs @ 70°C) | ISO 815 | 20% (max) |
| Operating Temperature | - | -40°C to +90°C |



The information contained on this product information sheet is to be used as guidance. The advice is given in good faith and does not constitute any guarantee or recommendation for suitability. The Rubber Company cannot be held liable for any damage caused by incorrect installation. We hereby reserve the right to change the technical information herewith without notification or prior agreement.