

## Expansion Joint Seal Profile 30mm x 28mm

Product Code: RCES2186

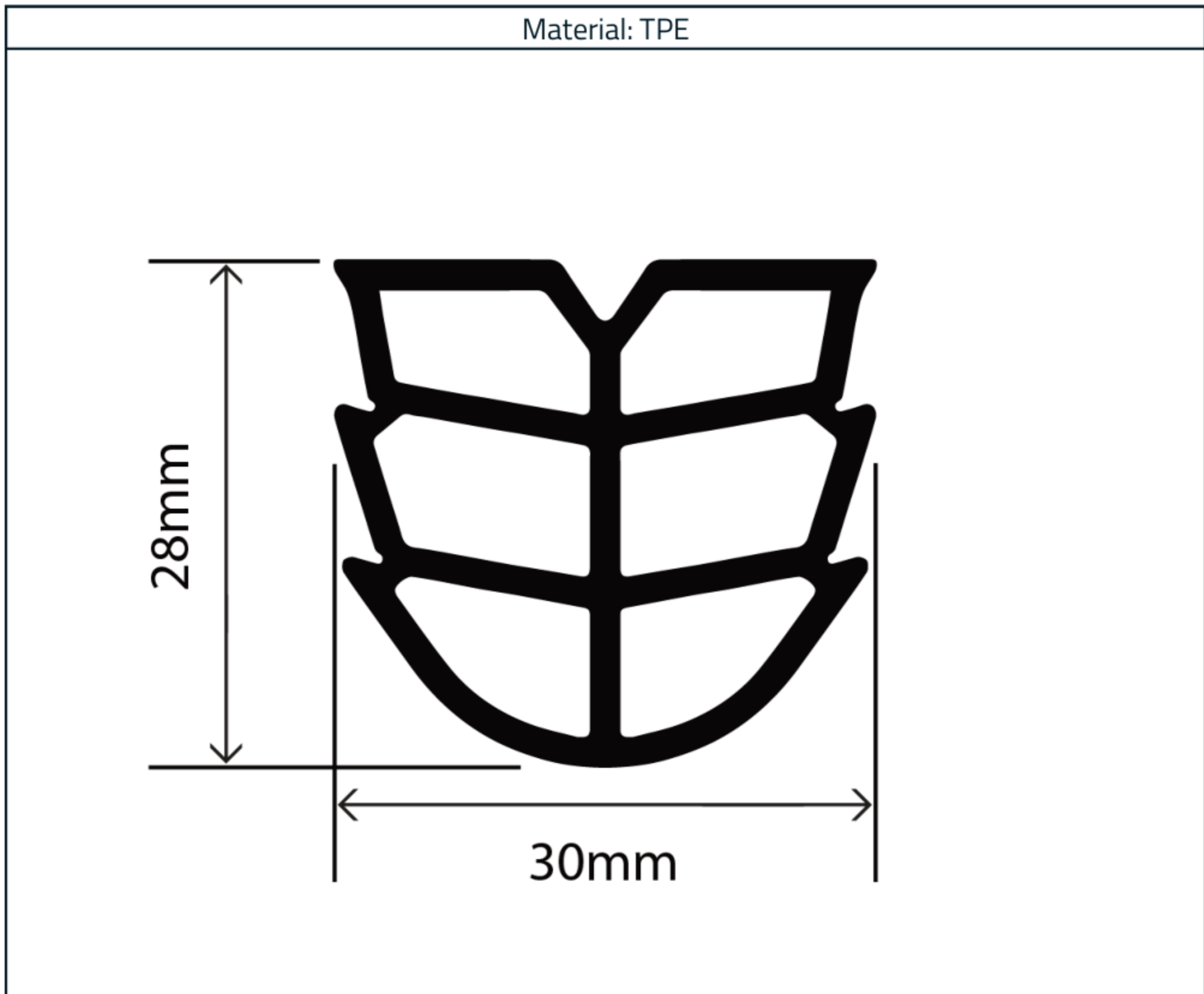

### Measurements:

Height	Width	To Fit Groove
28mm	30mm	22 - 26mm

The information contained on this product information sheet is to be used as guidance. The advice is given in good faith and does not constitute any guarantee or recommendation for suitability. The Rubber Company cannot be held liable for any damage caused by incorrect installation. We hereby reserve the right to change the technical information herewith without notification or prior agreement.

### Technical Data

RC-TPE404 is a material that has been specifically developed in order to conform to CSTB grade 4 and 5 requirements. It is a TPS-S.E.B.S type thermoplastic elastomer rubber. This particular compound provides excellent resistance against atmospheric agents, ageing, UV as well as moderate resistance to common chemicals.

RC-TPE404 is also 100% recyclable.

### Material Specification

Properties	Test Method	Values
Polymer	-	TPE
Hardness (Shore A)	ISO 868	70° +/- 5°
Density (Specific Gravity)	ISO 2781	1.18 g/cm <sup>3</sup>
Tensile Strength	ISO 37	7.4 MPa
Elongation at Break	ISO 37	528%
Remanent Deformation After Compression (22hrs @ 70°C)	ISO 815	48%
Remanent Deformation After Compression (22hrs @ 23°C)	ISO 815	23%
Remanent Deformation After Compression (22hrs @ 100°C)	ISO 815	65%
Young Modulus: Longitudinal - Transverse	-	12.7 N/mm <sup>2</sup> - 2.2 N/mm <sup>2</sup>
Operating Temperature Range	-	-50°C to +90°C



The information contained on this product information sheet is to be used as guidance. The advice is given in good faith and does not constitute any guarantee or recommendation for suitability. The Rubber Company cannot be held liable for any damage caused by incorrect installation. We hereby reserve the right to change the technical information herewith without notification or prior agreement.