

Expansion Joint Seal Profile 35mm x 35mm

Product Code: RCES1439

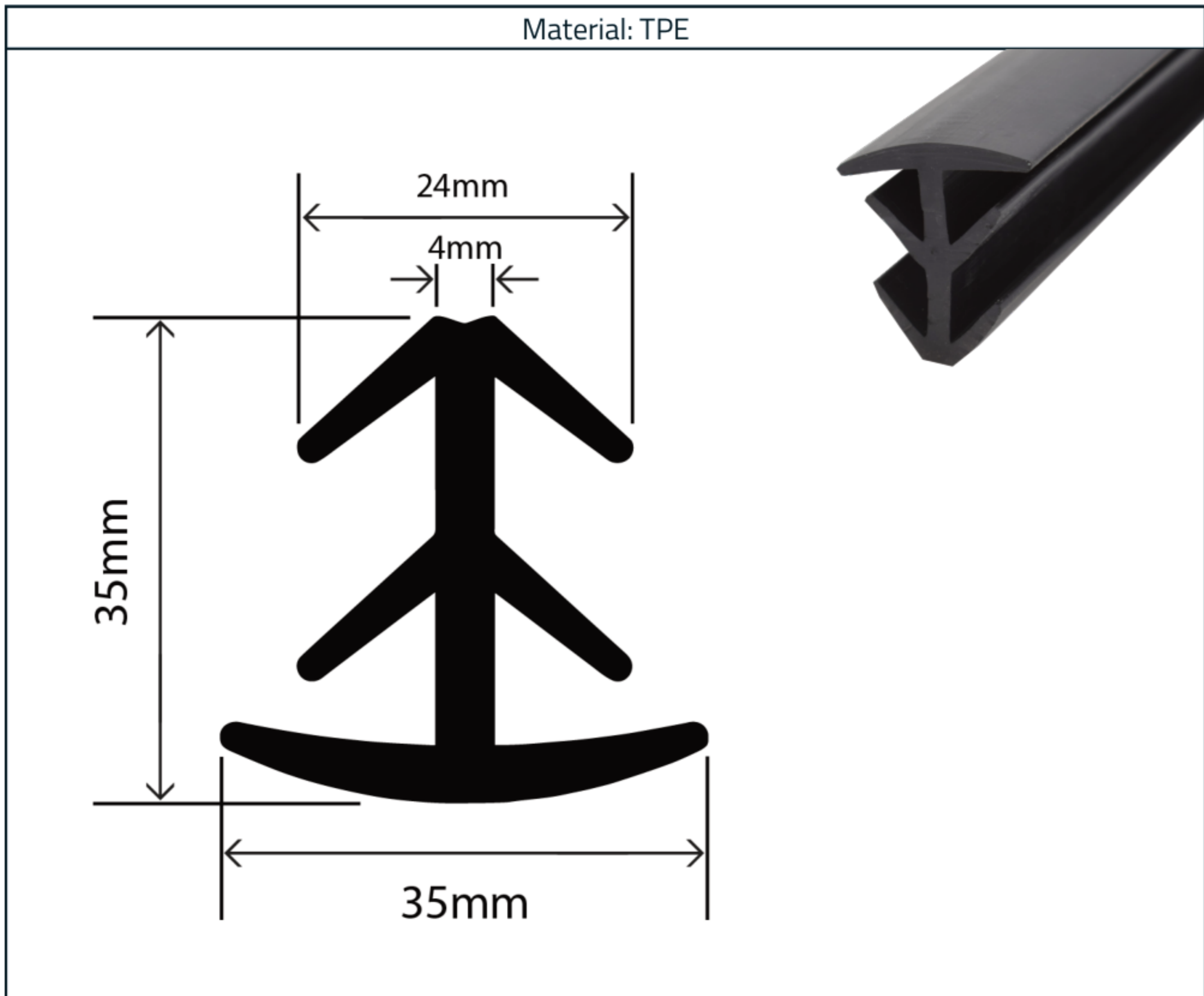

Measurements:

Height	Width	To Fit Groove
35mm	35mm	15 - 25mm

The information contained on this product information sheet is to be used as guidance. The advice is given in good faith and does not constitute any guarantee or recommendation for suitability. The Rubber Company cannot be held liable for any damage caused by incorrect installation. We hereby reserve the right to change the technical information herewith without notification or prior agreement.

Technical Data

RC-TPE503 is a TPV thermoplastic elastomer, that is based on PP-EPDM. It features good mechanical properties as well as good resistance against weathering and UV deterioration. It also provides very good chemical, acid and diluted bases resistance.

RC-TPE503 is also 100% recyclable.

Material Specification

Properties	Test Method	Values
Polymer	-	TPE
Hardness (Shore A)	ISO 868	60° +/- 5°
Density (Specific Gravity)	ASTM D792 - ISO 1183	0.97 g/cm ³
Tensile Strength	ASTM D412 - ISO 37	7.4 MPa
Elongation at Break	ASTM D412 - ISO 37	450%
Remanent Deformation After Compression (70hrs @ 125°C)	ASTM D395 B - ISO 815	48%
Remanent Deformation After Compression (22hrs @ 70°C)	ASTM D395 B - ISO 815	23%
Operating Temperature Range	-	-50°C to +90°C



The information contained on this product information sheet is to be used as guidance. The advice is given in good faith and does not constitute any guarantee or recommendation for suitability. The Rubber Company cannot be held liable for any damage caused by incorrect installation. We hereby reserve the right to change the technical information herewith without notification or prior agreement.