

Hollow TPE P Profile 27mm x 7mm

Product Code: RC4334

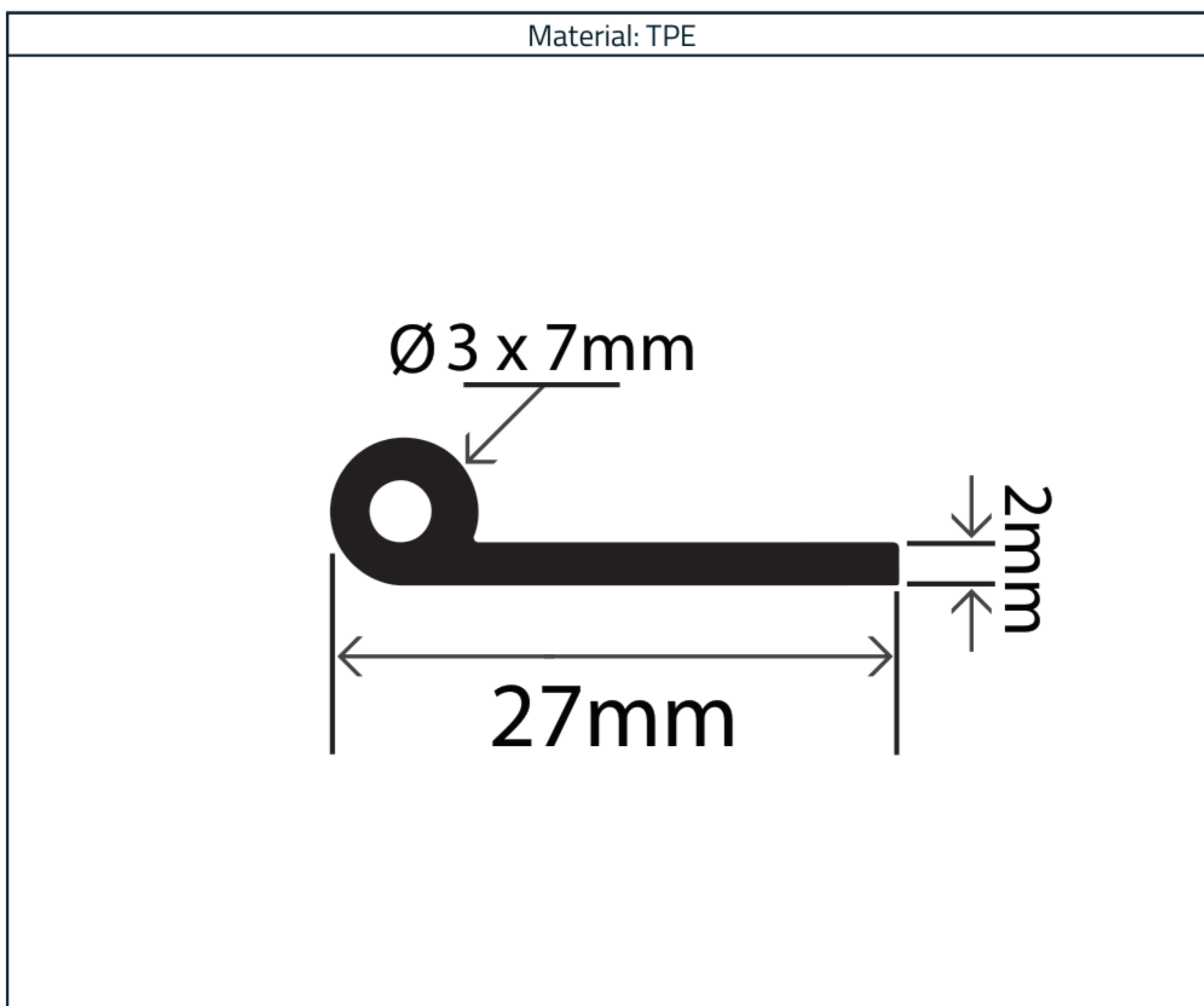

Measurements:

Height	Width	Bead Inner Diameter
7mm	27mm	3mm

The information contained on this product information sheet is to be used as guidance. The advice is given in good faith and does not constitute any guarantee or recommendation for suitability. The Rubber Company cannot be held liable for any damage caused by incorrect installation. We hereby reserve the right to change the technical information herewith without notification or prior agreement.

Technical Data

This profile is manufactured from our general purpose thermoplastic elastomer rubber (TPE) of the S.E.B.S type. It provides excellent resistance against outdoor ageing as well as good resistance to acids and bases.

This compound is 100% recyclable.

Material Specification

Properties	Test Method	Values
Polymer	-	TPE
Hardness (Shore A)	ISO 868	60° +/- 5°
Density	ISO 1183 1-A	Approx. 1.10 g/cm ³
Tensile Strength	ISO 37 / DIN 53504	7.70 N/mm ²
Elongation at Break	ISO 37 / DIN 53504	700%
Compression Set (72rs @ 23°C)	ASTM D395 89 B	21%
Compression Set (22rs @ 70°C)	ASTM D395 89 B	41%
Temperature Range (Working)	-	-65°C to +200°C



The information contained on this product information sheet is to be used as guidance. The advice is given in good faith and does not constitute any guarantee or recommendation for suitability. The Rubber Company cannot be held liable for any damage caused by incorrect installation. We hereby reserve the right to change the technical information herewith without notification or prior agreement.