

EPDM Rubber P Extrusion 38mm x 9.5mm

Product Code: RC3809

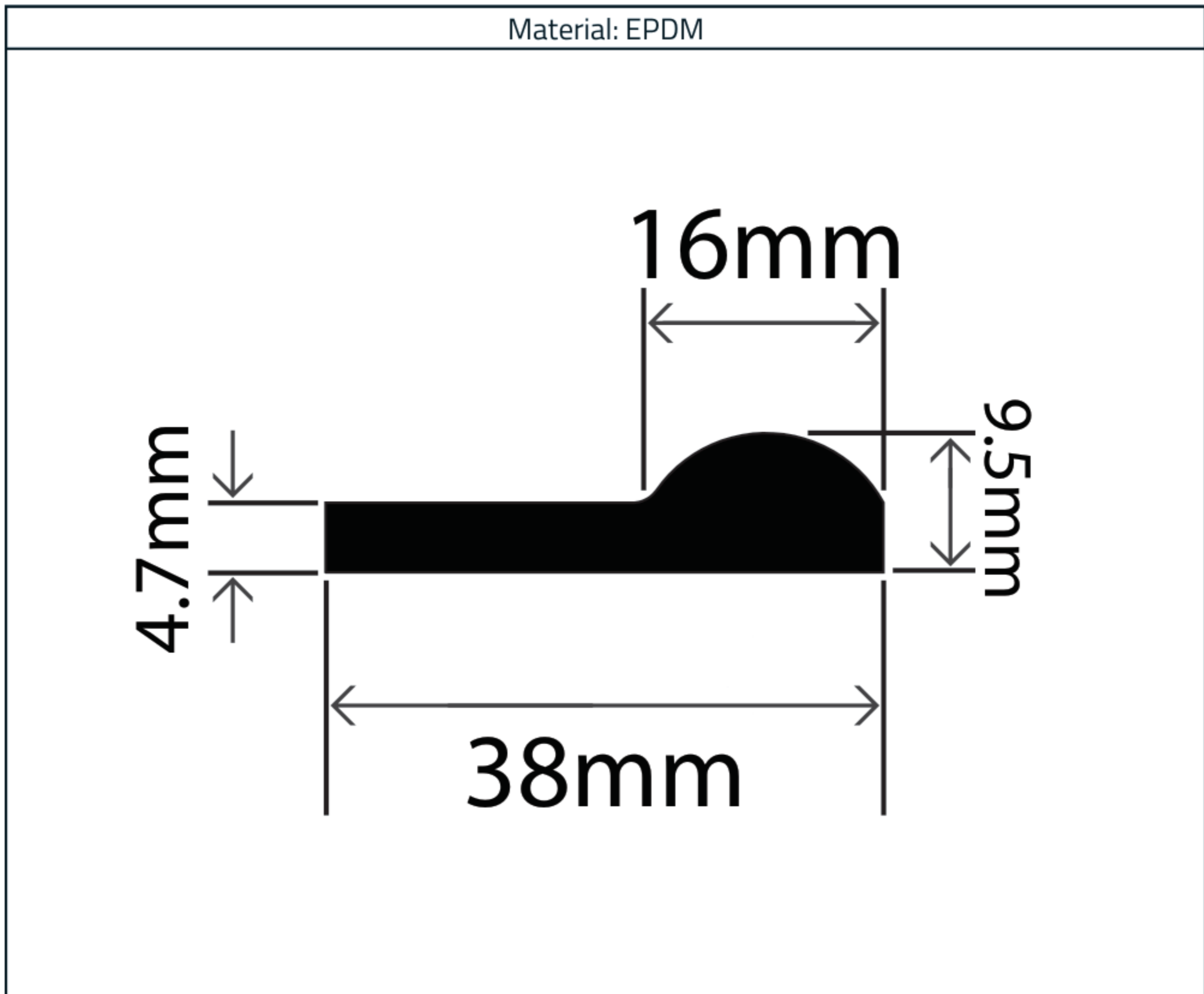

Measurements:

Height	Width
9.5mm	38mm

The information contained on this product information sheet is to be used as guidance. The advice is given in good faith and does not constitute any guarantee or recommendation for suitability. The Rubber Company cannot be held liable for any damage caused by incorrect installation. We hereby reserve the right to change the technical information herewith without notification or prior agreement.

Technical Data

Properties	Values
Hardness	65-75 IRHD
Tensile Strength	10 MPA
Elongation at break	500%
Tear Strength	50 kN/M
Compression Set (22 hours at 70 °C)	21%
Ozone Resistance (72 hours at 40 °C, 22PPHM, EXT)	No Cracks
Ages 70 hours at 70 °C Hardness Change	0 IRHD
Tensile Change	+ 9%
Elongation at break	0%



The information contained on this product information sheet is to be used as guidance. The advice is given in good faith and does not constitute any guarantee or recommendation for suitability. The Rubber Company cannot be held liable for any damage caused by incorrect installation. We hereby reserve the right to change the technical information herewith without notification or prior agreement.