

Natural Rubber D Profile 200mm x 200mm
 Product Code: RC0801-200

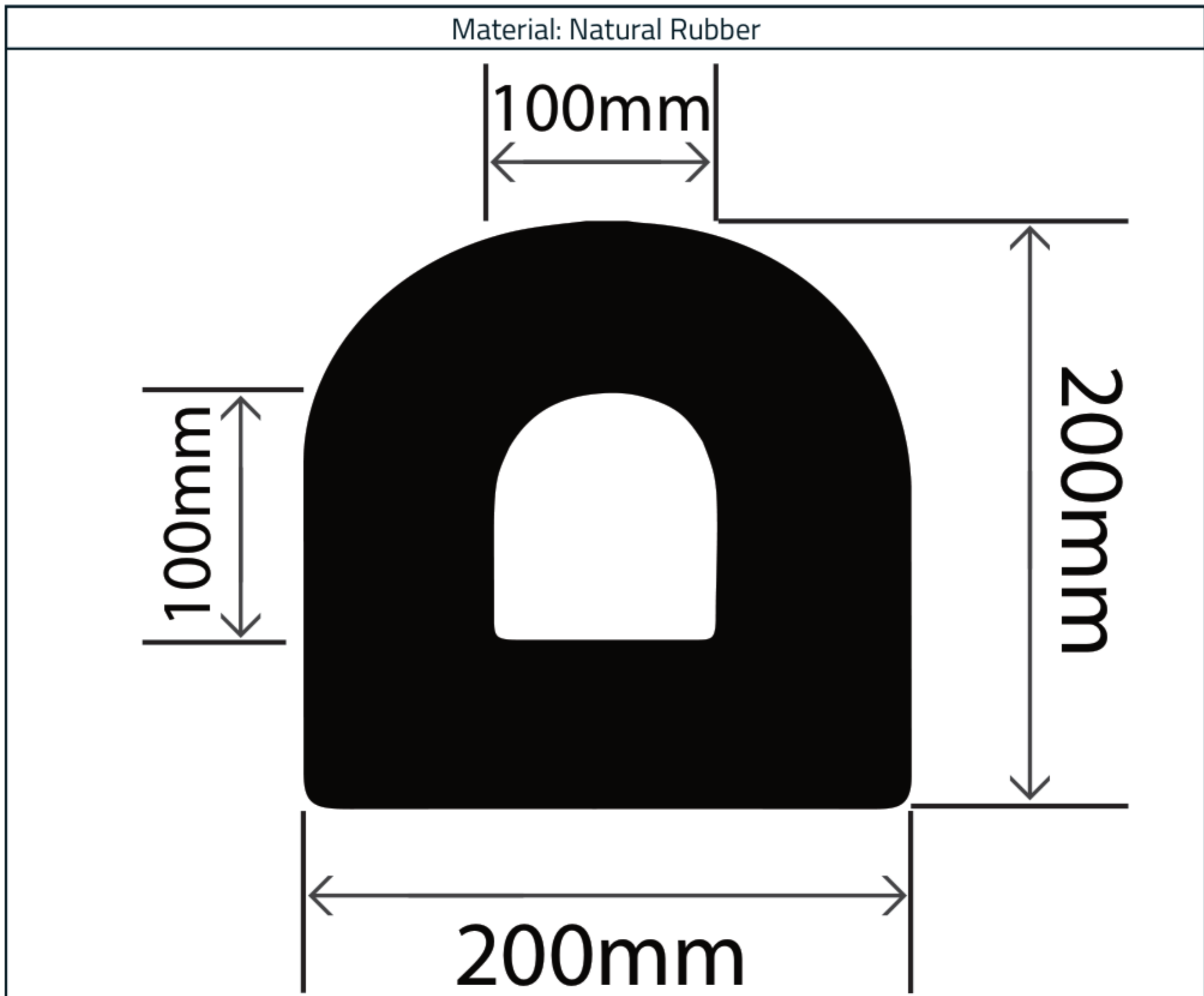

Measurements:

Height	Width
200mm	200mm

The information contained on this product information sheet is to be used as guidance. The advice is given in good faith and does not constitute any guarantee or recommendation for suitability. The Rubber Company cannot be held liable for any damage caused by incorrect installation. We hereby reserve the right to change the technical information herewith without notification or prior agreement.

Material Specification

Properties	Test Method	Values
Polymer	-	Natural Rubber
Hardness (Shore A)	DIN 53505	72°
Density	DIN 53505	1200 kg/m ³
Tensile Strength	DIN 53504	≥16MPa
Elongation at Break	DIN 53504	≥350%
Tear Resistance	DIN 53507	≥80 N/cm
Abrasion Resistance	DIN 53516	≤100mm ³
Compression Set (24hrs @ 70°C)	DIN 53517	≤40%
Ozone Resistance	ISO 143/1	No cracking visible
Air Ageing		
Change in Hardness	DIN 53505	≤5
Change in Tensile Strength	DIN 53504	≥80%
Change in Elongation At Break	DIN 53504	≥80%



The information contained on this product information sheet is to be used as guidance. The advice is given in good faith and does not constitute any guarantee or recommendation for suitability. The Rubber Company cannot be held liable for any damage caused by incorrect installation. We hereby reserve the right to change the technical information herewith without notification or prior agreement.