

PVC D Extrusion Profile 32mm x 24mm

Product Code: RC-P050

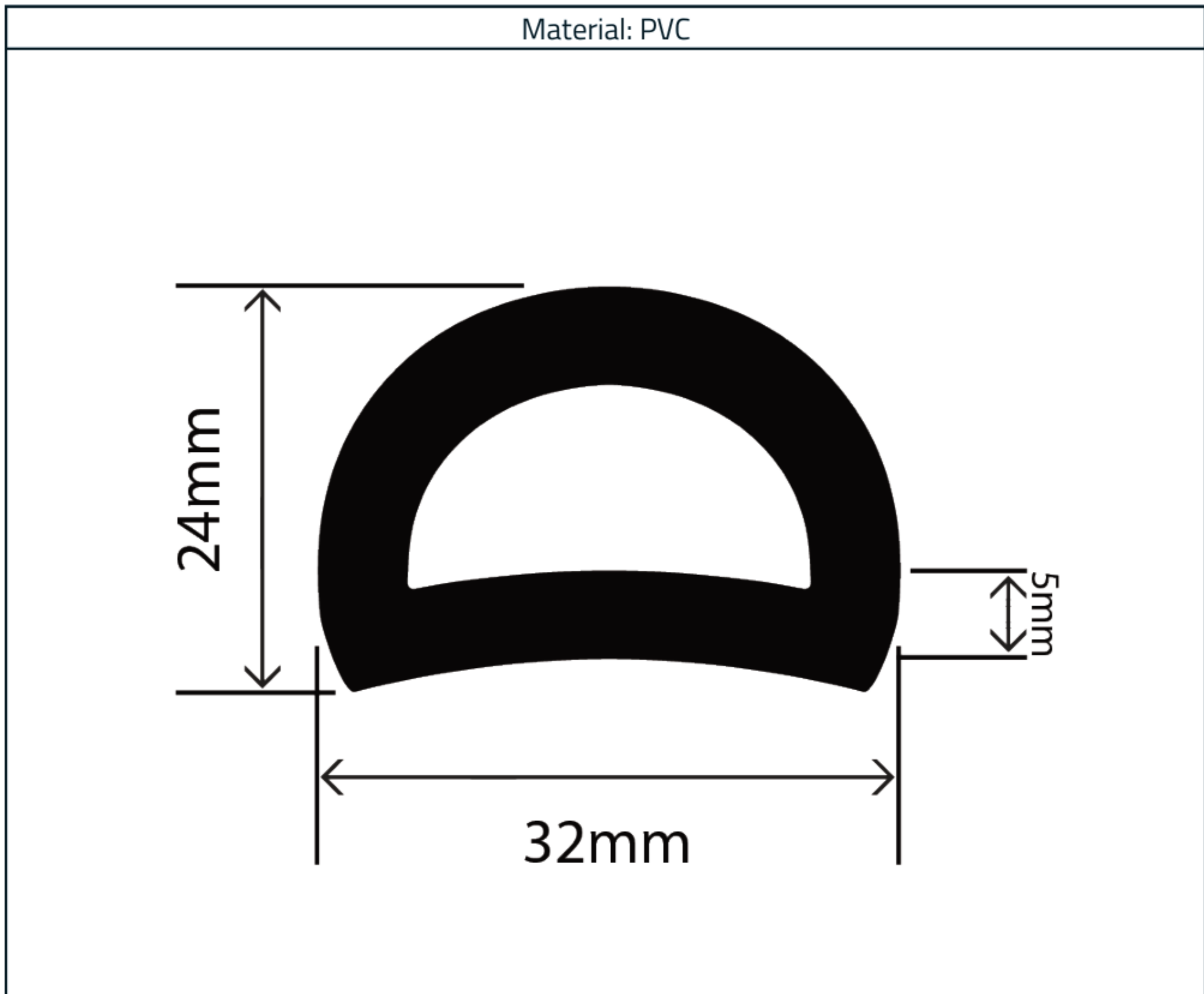

Measurements:

Height	Width
24mm	32mm

The information contained on this product information sheet is to be used as guidance. The advice is given in good faith and does not constitute any guarantee or recommendation for suitability. The Rubber Company cannot be held liable for any damage caused by incorrect installation. We hereby reserve the right to change the technical information herewith without notification or prior agreement.

Material Specification

Properties		Values
Compound	-	PVC
Hardness (Shore A)	-	67°
Softness (BSS Number)	BS2782 365A	58
Density (Specific Gravity)	BS2782 620A	1.24 g/cc
Tensile Strength	BS2782 320A	18.4 MN/m ²
Elongation at Break	BS2782 320A	390%
Modulus at 100%	BS2782 320A	7.58 MN/m ²
Cold Flex Temperature	BS2782 150B	-26°C



The information contained on this product information sheet is to be used as guidance. The advice is given in good faith and does not constitute any guarantee or recommendation for suitability. The Rubber Company cannot be held liable for any damage caused by incorrect installation. We hereby reserve the right to change the technical information herewith without notification or prior agreement.