

S Type Glazing Seal 21mm x 15.25mm

Product Code: RC-I4756.3

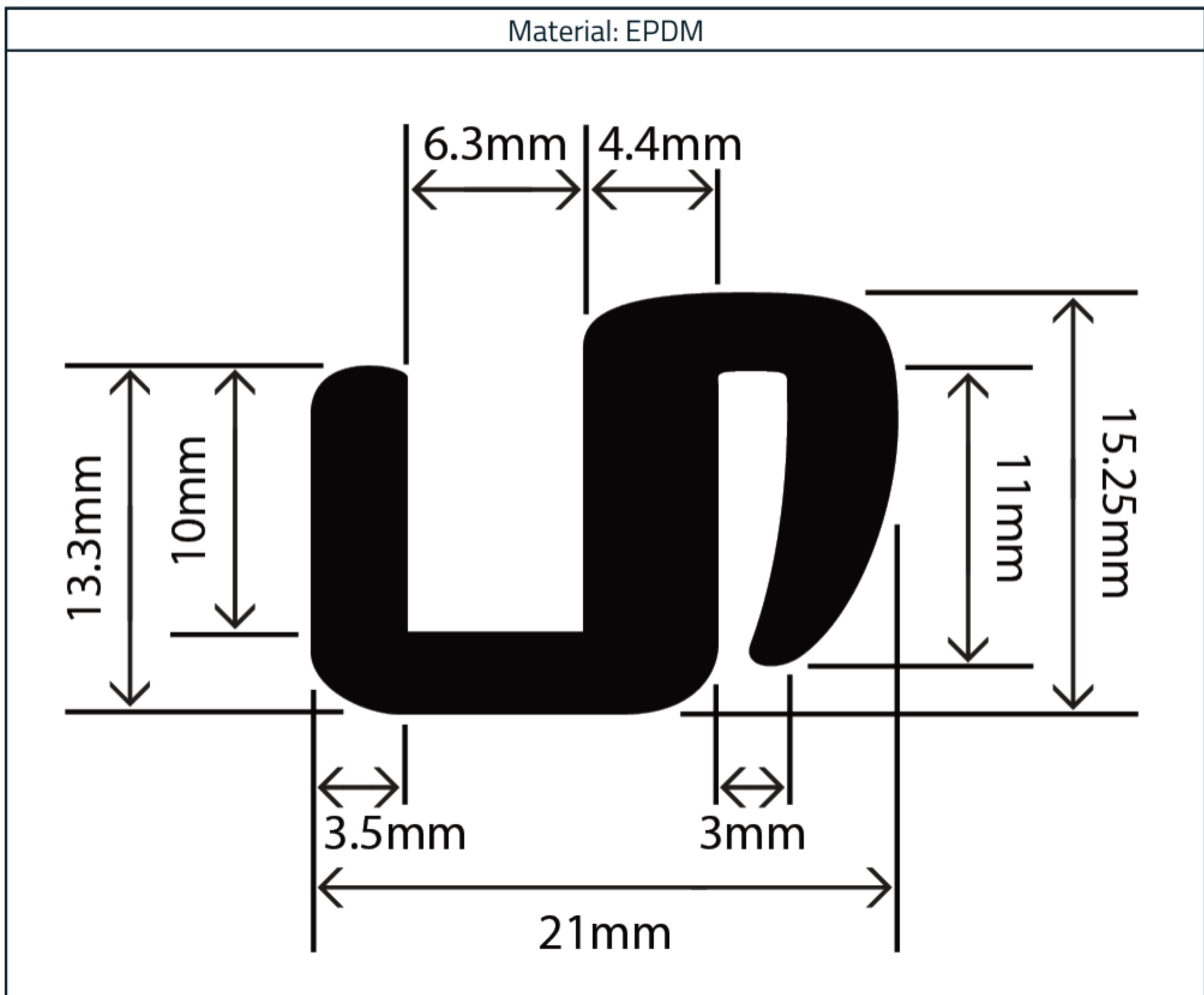

Measurements:

Height	Width	To Fit Panels
15.25mm	21mm	6.3mm & 3mm

The information contained on this product information sheet is to be used as guidance. The advice is given in good faith and does not constitute any guarantee or recommendation for suitability. The Rubber Company cannot be held liable for any damage caused by incorrect installation. We hereby reserve the right to change the technical information herewith without notification or prior agreement.

Technical Data

Material Specification

Properties	Values
Polymer	EPDM
Hardness (IRHD)	65-75
Tear Strength (KN/M)	50
Tensile Strength (MPA)	10
Compression Set (22 Hours at 70°C (%))	21
Elongation at Break (%)	500



The information contained on this product information sheet is to be used as guidance. The advice is given in good faith and does not constitute any guarantee or recommendation for suitability. The Rubber Company cannot be held liable for any damage caused by incorrect installation. We hereby reserve the right to change the technical information herewith without notification or prior agreement.