

Neoprene U Channel Profile 5.6mm x 12.5mm

Product Code: RC-I0728

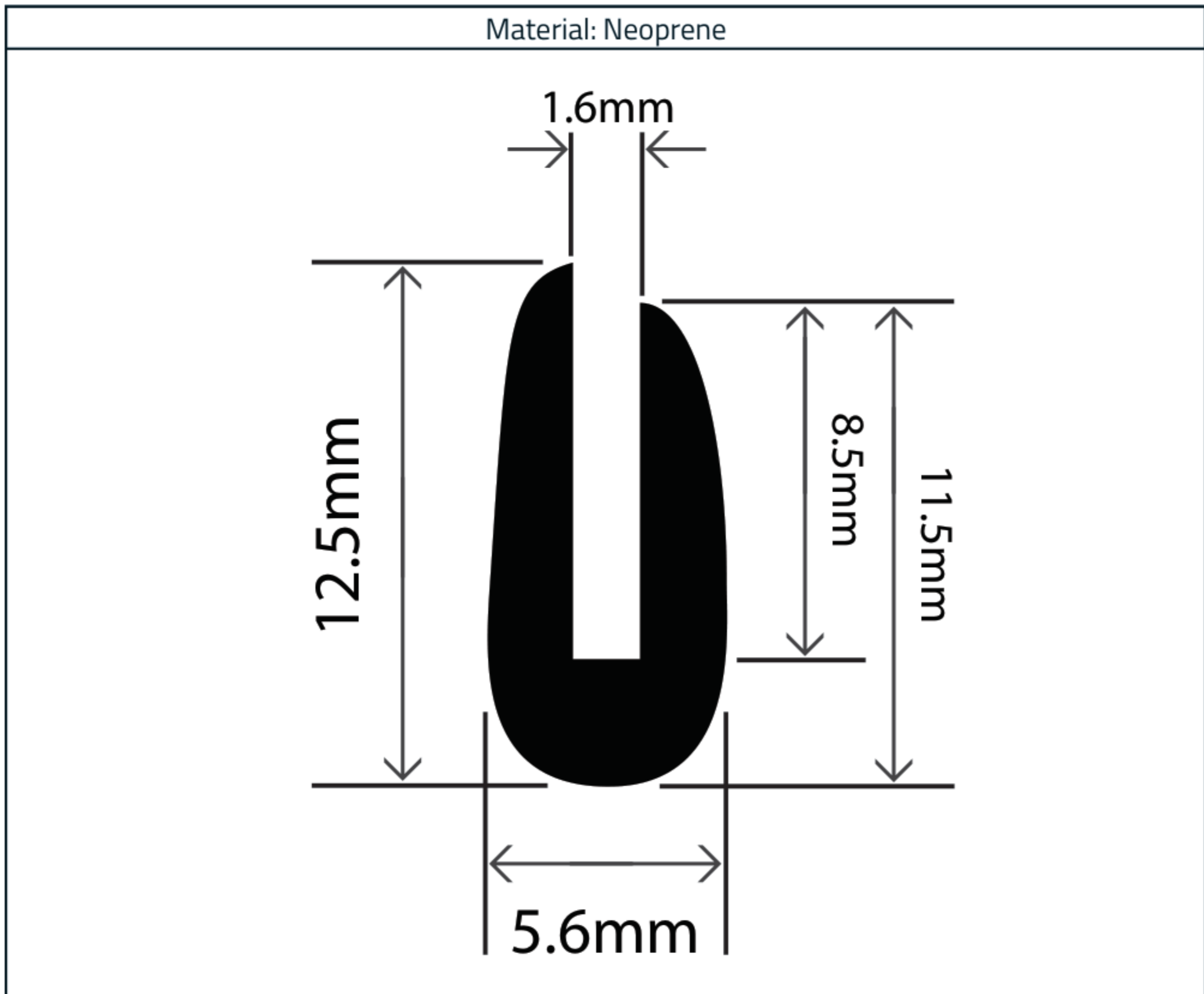

Measurements:

Height	Width	To Fit Panel
12.5mm	5.6mm	1.6mm

The information contained on this product information sheet is to be used as guidance. The advice is given in good faith and does not constitute any guarantee or recommendation for suitability. The Rubber Company cannot be held liable for any damage caused by incorrect installation. We hereby reserve the right to change the technical information herewith without notification or prior agreement.

Material Specification

Properties	Values
Polymer	CR
Hardness (IRHD)	65° - 75° +/- 5
Tensile Strength	5.00 MPa
Elongation at Break	400%
Tear Strength	17 kn/m
Compression Set (22hrs @ 70°C)	70%
Ozone Resistance (72hrs @ 40°C, 25pphm)	Some Cracks
Heat Aging (70hrs @ 70°C)	
Change in Shore Hardness	+7°
Change in Tensile Strength	+15%
Change in Elongation at Break	-17%
Working Temperature Range	-20°C to +90°C



The information contained on this product information sheet is to be used as guidance. The advice is given in good faith and does not constitute any guarantee or recommendation for suitability. The Rubber Company cannot be held liable for any damage caused by incorrect installation. We hereby reserve the right to change the technical information herewith without notification or prior agreement.