

EPDM U Channel Profile 6mm x 6mm

Product Code: RC-B1217

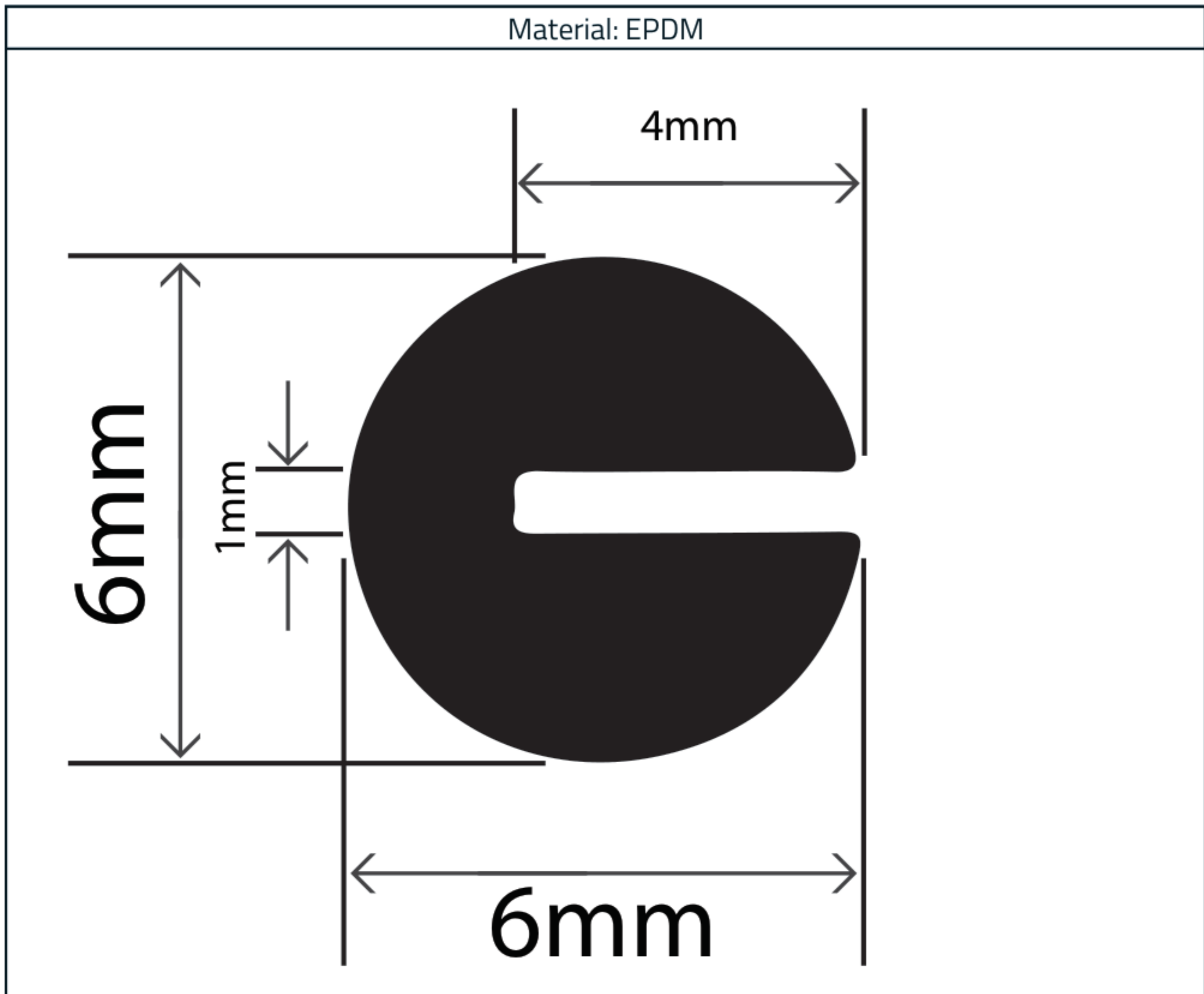

Measurements:

Height	Width	To Fit Panel
6mm	6mm	1mm

The information contained on this product information sheet is to be used as guidance. The advice is given in good faith and does not constitute any guarantee or recommendation for suitability. The Rubber Company cannot be held liable for any damage caused by incorrect installation. We hereby reserve the right to change the technical information herewith without notification or prior agreement.

Material Specification

Properties	Values
Polymer	EPDM
Hardness (IRHD)	69 +/- 5°
Tensile Strength	10.50 MPa
Elongation at Break	315%
Tear Strength	12 kn/m
Compression Set (22hrs @ 70°C)	7%
Ozone Resistance (98hrs @ 40°C, 100pphm)	6
Cold Bend Test (-30°C)	No Cracks
Migration Resistance	0.02 mg
Staining Resistance	No Stain
UV Stability	No Cracks
Heat Aging (70hrs @ 70°C)	
Change in Shore Hardness	2°
Change in Tensile Strength	5%
Change in Elongation at Break	0%
Heat Aging (10 days @ 70°C)	
Change in Shore Hardness	2°
Change in Tensile Strength	-1%
Change in Elongation at Break	7%



The information contained on this product information sheet is to be used as guidance. The advice is given in good faith and does not constitute any guarantee or recommendation for suitability. The Rubber Company cannot be held liable for any damage caused by incorrect installation. We hereby reserve the right to change the technical information herewith without notification or prior agreement.